

INVERTER



AIRSTAGE™

Variable Refrigerant Flow System
Multi Air Conditioning System for Buildings

The Intelligent Choice in Comfort

J SERIES

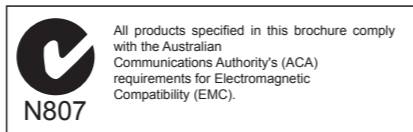

ISO 9001
Certified number:09 100 79269
Fujitsu General (Shanghai) Co., Ltd.

ISO 14001
Certified number:104692

ISO 9001
Certified number:09 100 89394

ISO 14001
Certified number:09 104 9245

"AIRSTAGE™" is a worldwide trademark of FUJITSU GENERAL LIMITED.
FUJITSU brand lineup except for compact cassette (AU7 - 18) was certified by China Compulsory Certification.

All specifications subject to change without prior notice.

Copyright© 2003-2007 Fujitsu General Limited. All rights reserved.

Distributed by :

FUJITSU GENERAL LIMITED
1116, Suenaga, Takatsu-ku, Kawasaki 213-8502, Japan
URL : <http://www.fujitsu-general.com>

2008.04 VB009E/10

FUJITSU GENERAL LIMITED

High-performance air conditioning system

The compact VRF System provides economical and comfortable air conditioning for wide range of applications from living space to business space.

Compact VRF System for use in apartments, homes, shops, offices

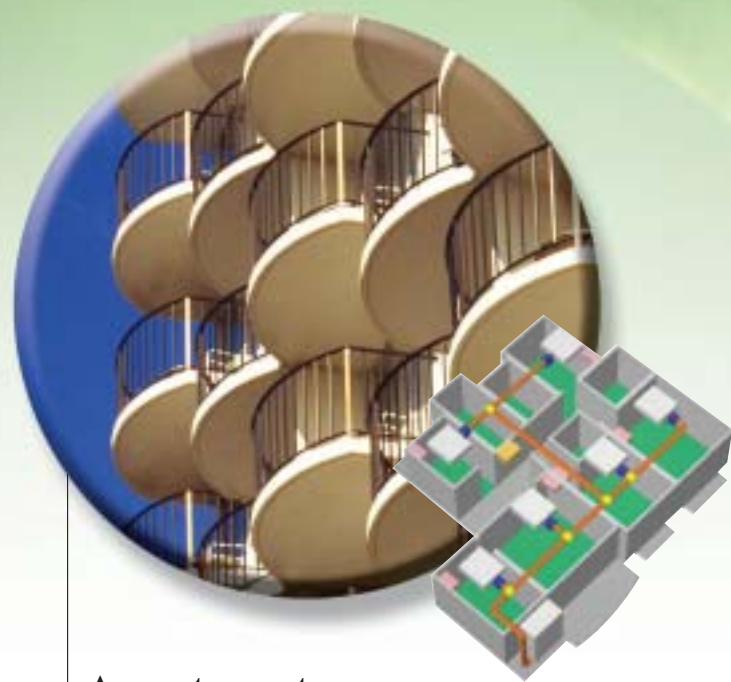

Apartments

The common areas and individual room spaces in apartment blocks have differing air conditioning needs. What is required is an air conditioning system that provides comfortable conditions and is economical and surroundings conscious.

Homes

Homes need individual air conditioning control for specific rooms that can also be easily switched to standby mode if the occupants have to go out at short notice.



A range which allows an unlimited combination of indoor and outdoor units accord

Outdoor units

Heat Pump R410A	Cooling Only R410A
AJA54L/AO54U	AJA54J/AO54F
P4, P5	

Indoor units

Compact Cassette	Cassette	Compact Duct	Low Static Pressure Duct	Duct
AU7 / AU9 / AU12 / AU14 / AU18	<small>Slim Type</small> AU20 / AU25 / AU30 AU36 / AU45 / AU54	AR7 / AR9 AR12 / AR14 / AR18 / AR22	<small>Silent Model</small> ARXB25 / ARXB30	AR25 / AR30 / AR36 / AR45
P14	P15	P16	P17	P17

Piping material

- Use the correct refrigerant piping and materials for R410A.
- For the pipe wall thickness, see the table below.

Copper pipe outside diameter(Ø)	Ø 6.35	Ø 9.52	Ø 12.70	Ø 15.88	Ø 19.05
Material	Copper JIS H3300 C1220T-O or equivalent ¹⁾				
Copper pipe ²⁾ wall thickness (mm)	0.8	0.8	0.8	1.0	1.2

Note: Always observe and follow the necessary local regulations when installing refrigerant piping.
1) Allowable tensile stress ≥ 33 (N/mm²); 2) Design pressure 4.2MPa.

Tools

- R410A work requires a number of special tools (* symbol).
- Since tools used in R22 work cannot be used, provide the tools separately.

Tool name	Process and application	
Pipe cutter	Pipe cutting	Refrigerant piping work
* Flaring tool	Pipe flaring work	
* Torque wrench (1/2, 5/8)	Flare nut connection	
Expander	Expansion at pipe connection	
Pipe bender	Pipe bending work	
Nitrogen gas	Pipe interior oxidation prevention	Air tightness test
Welder	Pipe brazing	
* Gauge manifold	Vacuum evacuation and refrigerant charging operation check	Air tightness test ~ Refrigerant additional charging
* Charging hose		
* Vacuum pump(with adaptor)	Vacuum drying	
Electronic scale for refrigerant charging	Refrigerant additional charging	
Gas leak tester		

Work precautions

Refrigerant check Before work, check the refrigerant used and prepare materials matched to the refrigerant.

Refrigerant piping work Observe the basics (dry, clean) of refrigerant piping and carry out work so that problems will not occur. Moreover, when performing welding work, seal in nitrogen gas and perform work so that an oxide film is not produced.



Leak pressure test Conduct a pressure test sufficiently and make sure there is no refrigerant leakage.

Vacuum drying If the vacuum pump does not have a reverse flow check mechanism, use the pump together with a reverse flow check adapter.

Additional refrigerant Charge only the amount of R410A refrigerant calculated in the additional refrigerant charge calculation. This refrigerant should only be charged in a liquid form.

R410A Work Notes

R410A

The working pressure of R410A is approximately 1.6 times higher than that of R22.
As the oil type is also different, be sure not to mix them.

Refrigerant	R410A	R407C	R22
Oil	POE oil	POE oil	Mineral oil
Pressure ratio	Approx. 1.6	Approx. 1.1	1

Work flow

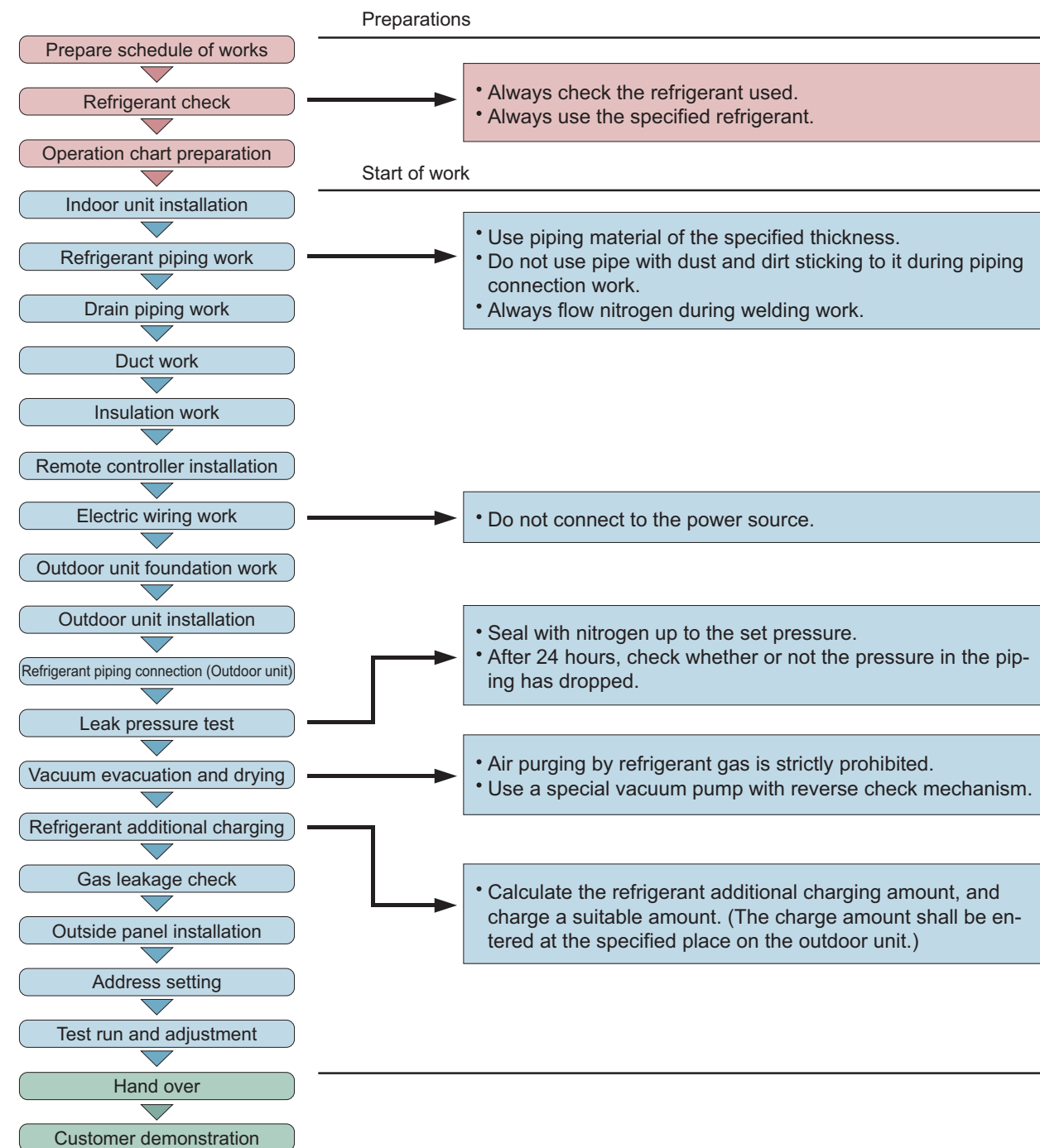

A compact VRF System that responds to the needs of each building

Backed by advanced air conditioning technology, this compact VRF System was developed to meet six key requirements: high efficiency, economy, comfort, convenience, ease of operation, and easy maintenance. This VRF System delivers a comfortable and economical environment.

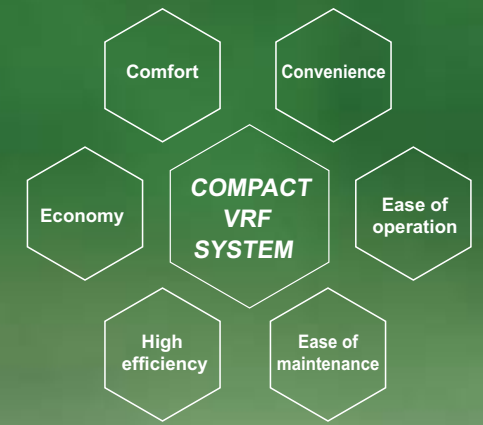

and a broad range of other applications



Shops

As shop premises are regularly upgraded and the operating conditions for each can vary so much, large-scale air conditioning management is very difficult. Consequently, a VRF air conditioning system matched to each shop is an ideal solution.

Offices

The spaces within office premises can all have different air conditioning requirements. Energy saving and economic operation are major issues and what is needed is an air conditioning system which can be accurately matched to each space and centrally controlled.



ing to the building and application

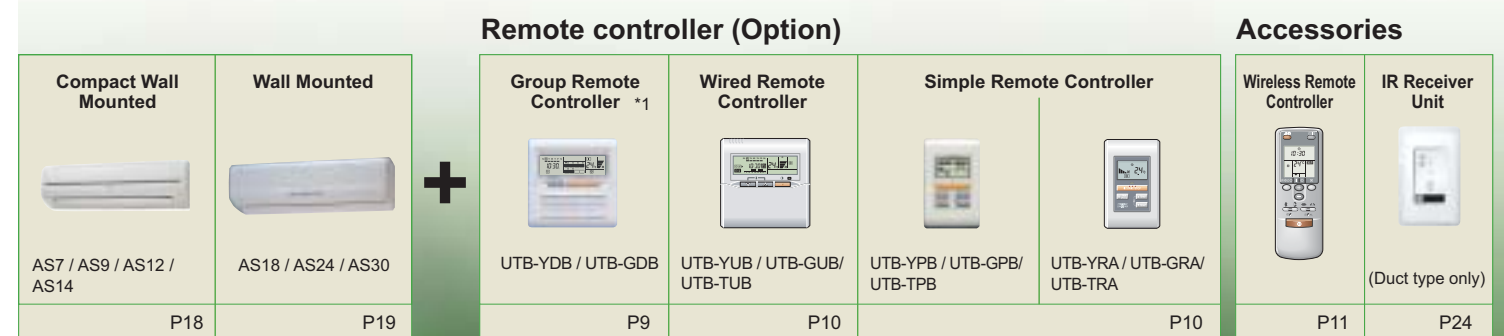

*1. Network converter (UTR-YGCA) is required, when installing group remote controller.

High-performance outdoor unit delivering com



R410A Heat Pump Cooling Only
 AJ*A54LCLR AJ*A54JCLR
 AO*54UJBM AO*54FJBM

※ AJ*A: AJYA (FUJITSU) AJ*A: AJGA (GENERAL)
 AO*: AO (FUJITSU) AO*: AOG (GENERAL)

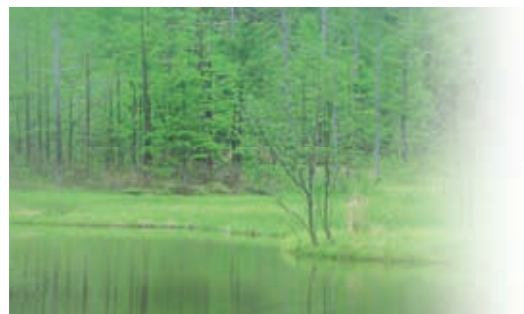

Powerful operation with low electricity consumption

- Excellent COPs are attainable as shown in the table below.
- Uses a high-performance DC inverter scroll compressor with variable capacity according to the load during cooling and heating.

Cooling COP	3.20*
Heating COP	3.40*

* COP* is the coefficient of performance (= capacity (kW) ÷ input power (kW)).
 ※ COP values are based on our own testing method.



High-capacity connection possible

- One outdoor unit can connect to up to 8 indoor units.
- Connectable capacity is 150% of the outdoor unit rating and can cope with a range of operating modes.

Max 8 indoor units connectable

Indoor unit connectable capacity 150%

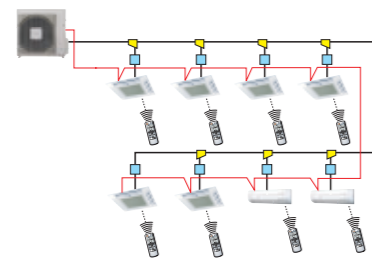

When all indoor units are operating at maximum capacity, individual indoor units operate at slightly lower capacity when connecting more than 100%.

Operating outside air temperature range

- Outdoor unit operates over an ambient temperature range of -5°C to 43°C for cooling and -20°C to 21°C for heating.

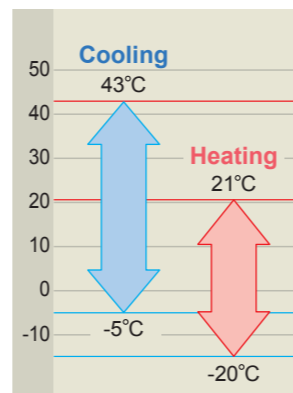

Optional Parts

EV kit

UTR-EV2AXL
UTR-EV3XL

• EV kit is available for installation as necessary.
 Model code < 30 : UTR-EV2AXL
 Model code ≥ 30 : UTR-EV3XL



Separation tube

UTR-BP054X / UTR-BP54U

• Separation tubes are available for installation as necessary.

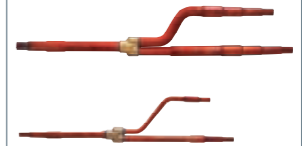

Grille kit

UTG-UDYD-W
UTG-UDGD-W

• Grille for compact cassette type indoor unit.



Header

UTR-HD546U

• Headers are available for installation as necessary.



Remote sensor unit

UTD-RS100

• Thermo sensor for sensing the temperature of an arbitrary place in the room



Drain pump unit

UTZ-PX1BBA

• For compact duct type



Flange (Square)

UTD-SF045T

• For duct type
205 x 1,063, L=40 (mm)



Air clean filter

UTR-FA08

• For wall mounted type
• Air clean filter assembly for initial setting.

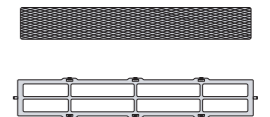

Flange (Round)

UTD-RF204

• For duct type
∅195 (∅205), L=85 (mm)



Air clean filter

UTR-FB03

• Replacement filter for UTR-FA08



Long-life filter

UTD-LF270

• For duct type

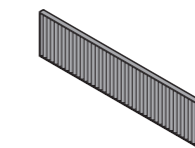

Accessories

Wireless remote controller

- Supplied with each indoor unit



IR receiver unit

- IR receiver unit is connected for each duct type indoor unit.



Optional Parts

Group remote controller

UTB-YDB / UTB-GDB

- Up to 8 indoor units can be controlled by a single controller.
- When air conditioner ON/OFF and temperature setting are preset automatically by using a weekly timer, operation can be started and stopped automatically.



Network converter

UTR-YGCA

- Network converter is required to connect Group Remote Controller to an VRF system.

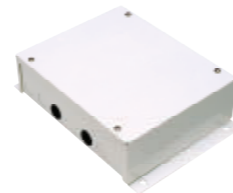

Wired remote controller

UTB-YUB / UTB-GUB
UTB-TUB

- Wired remote controller capable of controlling each indoor unit individually.
- Can be used together with wireless remote controller.

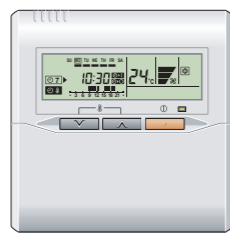

Simple remote controller

UTB-YPB / UTB-GPB
UTB-TPB

- Concentrates on basic operations such as On/Off, Fan Control, Master Control and Temperature Setting.



Simple remote controller

UTB-YRA / UTB-GRA
UTB-TRA

- Concentrates on basic operations such as On/Off, Fan Control and Temperature Setting.



External switch controller

UTR-YESA

- Switching of the air conditioner can be controlled by connecting other sensor switches.

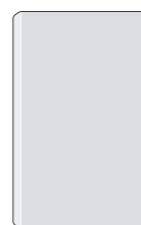

fort and economy

Lightweight and compact design

- Small, compact casing can be easily concealed.

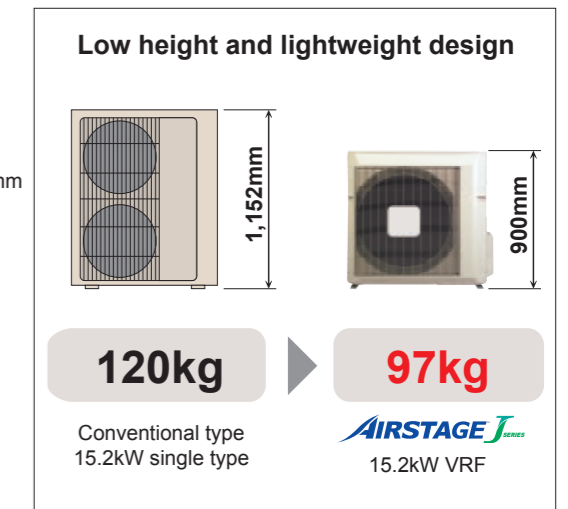
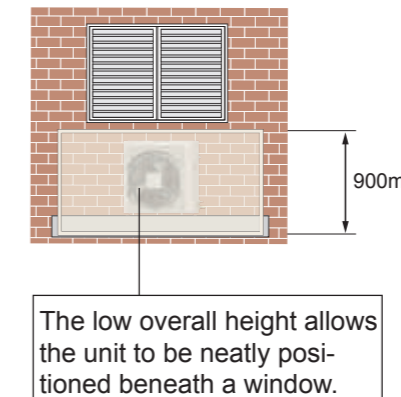

Noise reduction

- Newly designed larger fan and double casing bell mouth construction reduce noise emissions.

Large fan

Low-speed design suppresses noise by using a larger fan.

Blue fin heat exchanger mounted

- Corrosion-resistance of the heat exchanger even in coastal areas has been improved by blue fin treatment of the outdoor unit heat exchanger.

Blue fin heat exchanger

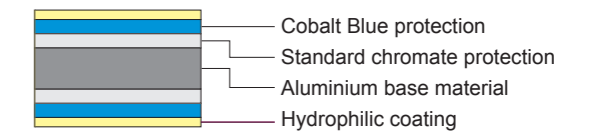

*Cobalt blue protection (Blue Fin) is a standard specification of AJ*A54LCLR, AJ*A54JCLR.

Double casing bell mouth

Double casing bell mouth helps to reduce noise.

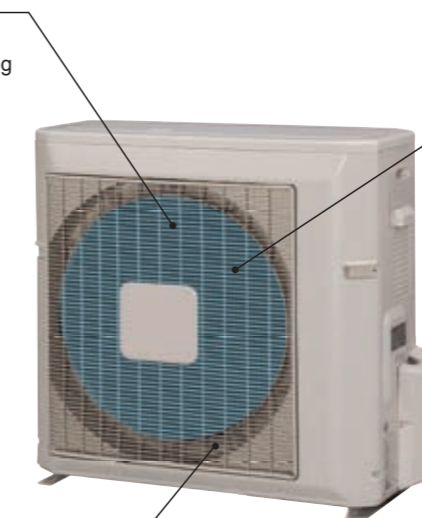

Compact VRF System allows design flexib

Flexible design Superior design flexibility allows individual air conditioning of multiple rooms.

System that allows individual air conditioning of multiple rooms

Homes

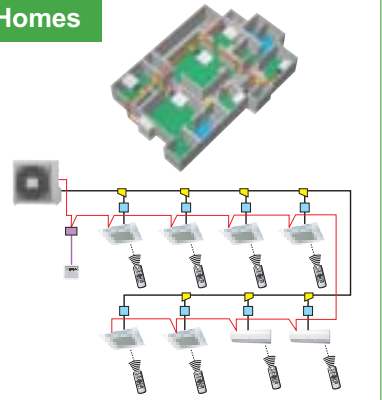

Shops

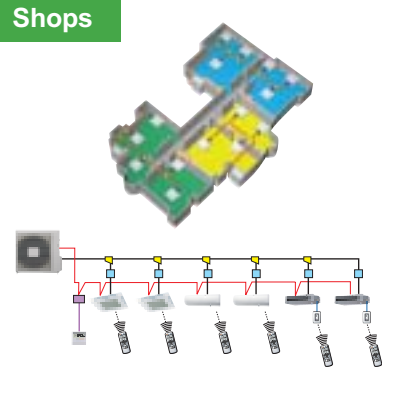

Offices

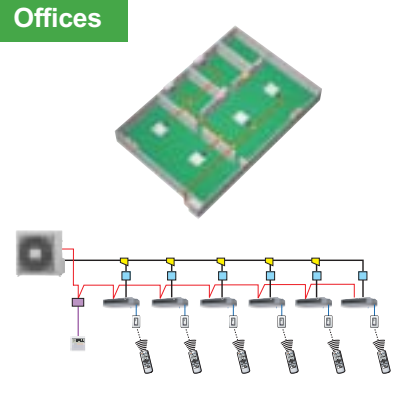

Piping connection examples

Separation tube system

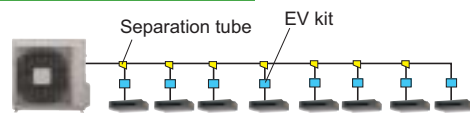

Separation tube + header system

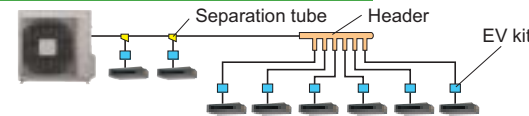

Easier outdoor unit installation

- Discreet installation

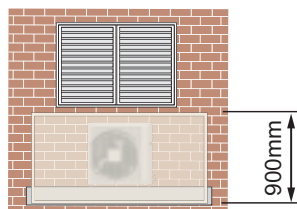

Height	900
Width	900
Depth	370

Unit: mm

The compact dimensions allow the outdoor unit to be installed below a window.

Large capacity connectable

- Up to 8 indoor units can be connected to 1 outdoor unit. Furthermore, the indoor unit connection capacity can be up to 150% of the outdoor unit rating. This increases design flexibility.

Max 8
Indoor units
connectable

150%
Connectable
capacity

Long piping length

- The maximum piping length is 70m, and can cope with a wide range of applications from homes to offices.

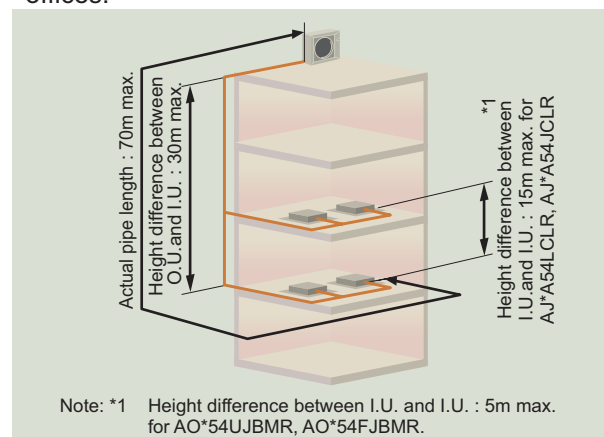

All indoor units are supplied with a remote controller

- All indoor units come with a wireless remote controller.

Note: IR receiver unit is available for duct type indoor unit.

Indoor unit Compact Duct (Unit : mm)

Models: AR7 / AR9 / AR12 / AR14 / AR18 / AR22

*Service accessibility must be allowed for when installing the product. Please consult the installation manual for the necessary service access size.

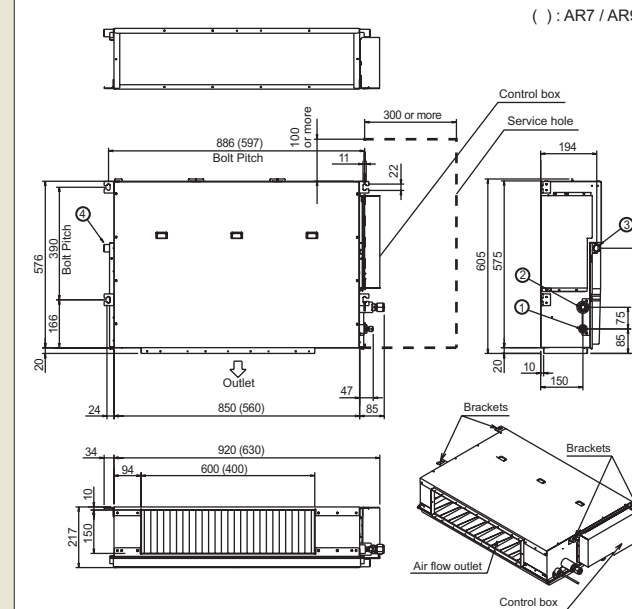

Indoor unit Low Static Pressure Duct / Duct (Unit : mm)

Models: ARXB25 / ARXB30 / AR25 / AR30 / AR36 / AR45

*Service accessibility must be allowed for when installing the product. Please consult the installation manual for the necessary service access size.

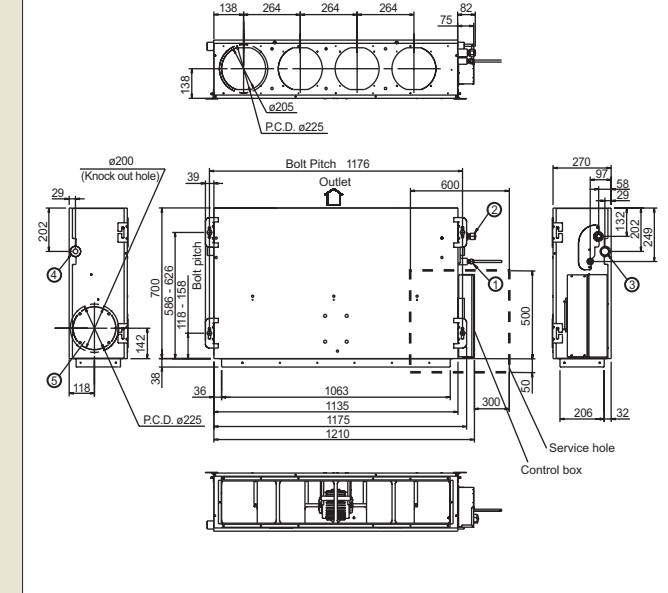

Indoor unit Compact Wall Mounted (Unit : mm)

Models: AS7 / AS9 / AS12 / AS14

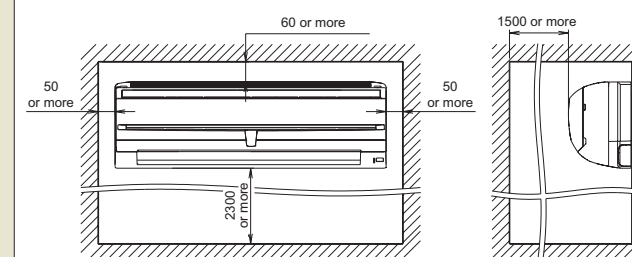
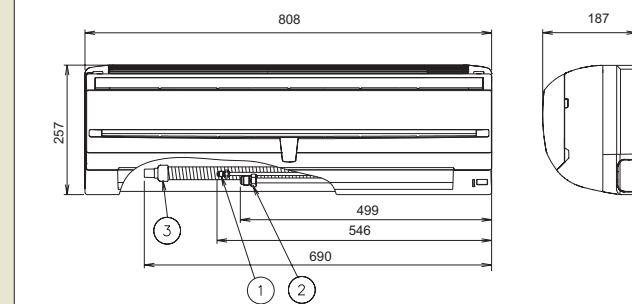

Indoor unit Wall Mounted (Unit : mm)

Models: AS18 / AS24 / AS30

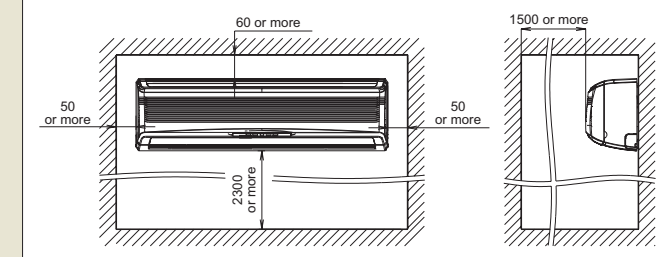
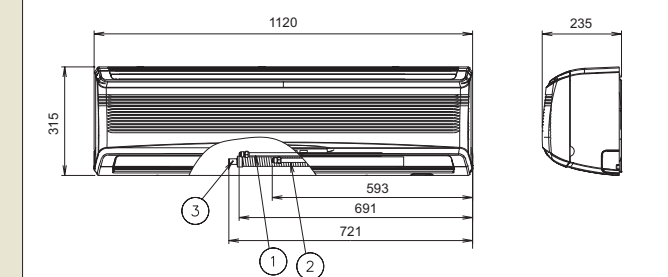

Dimensions

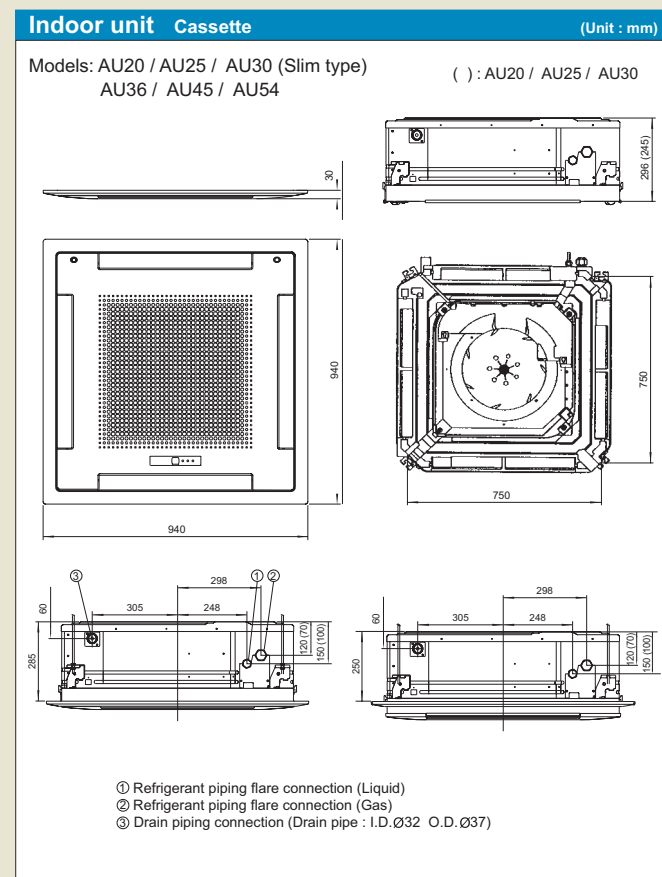
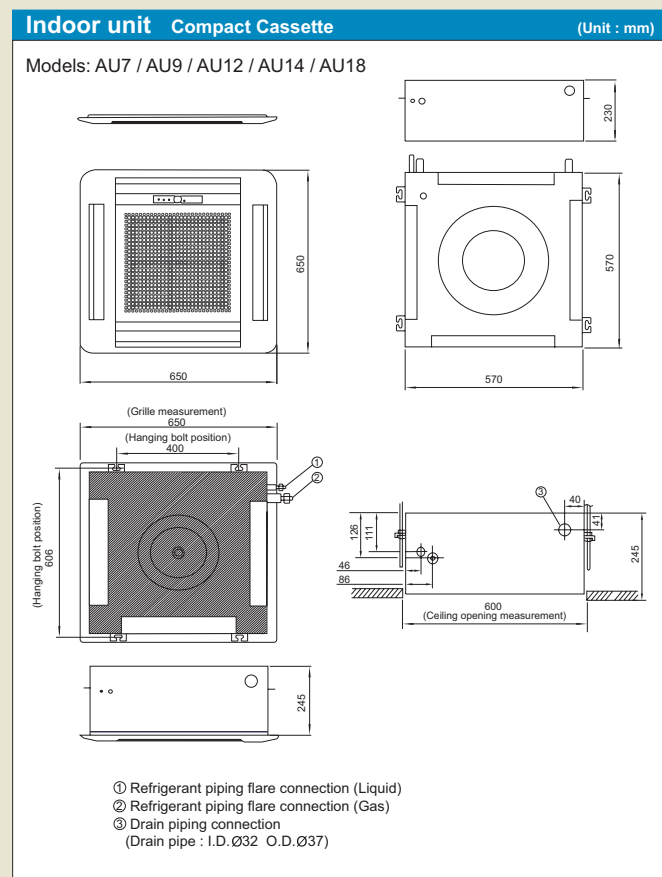
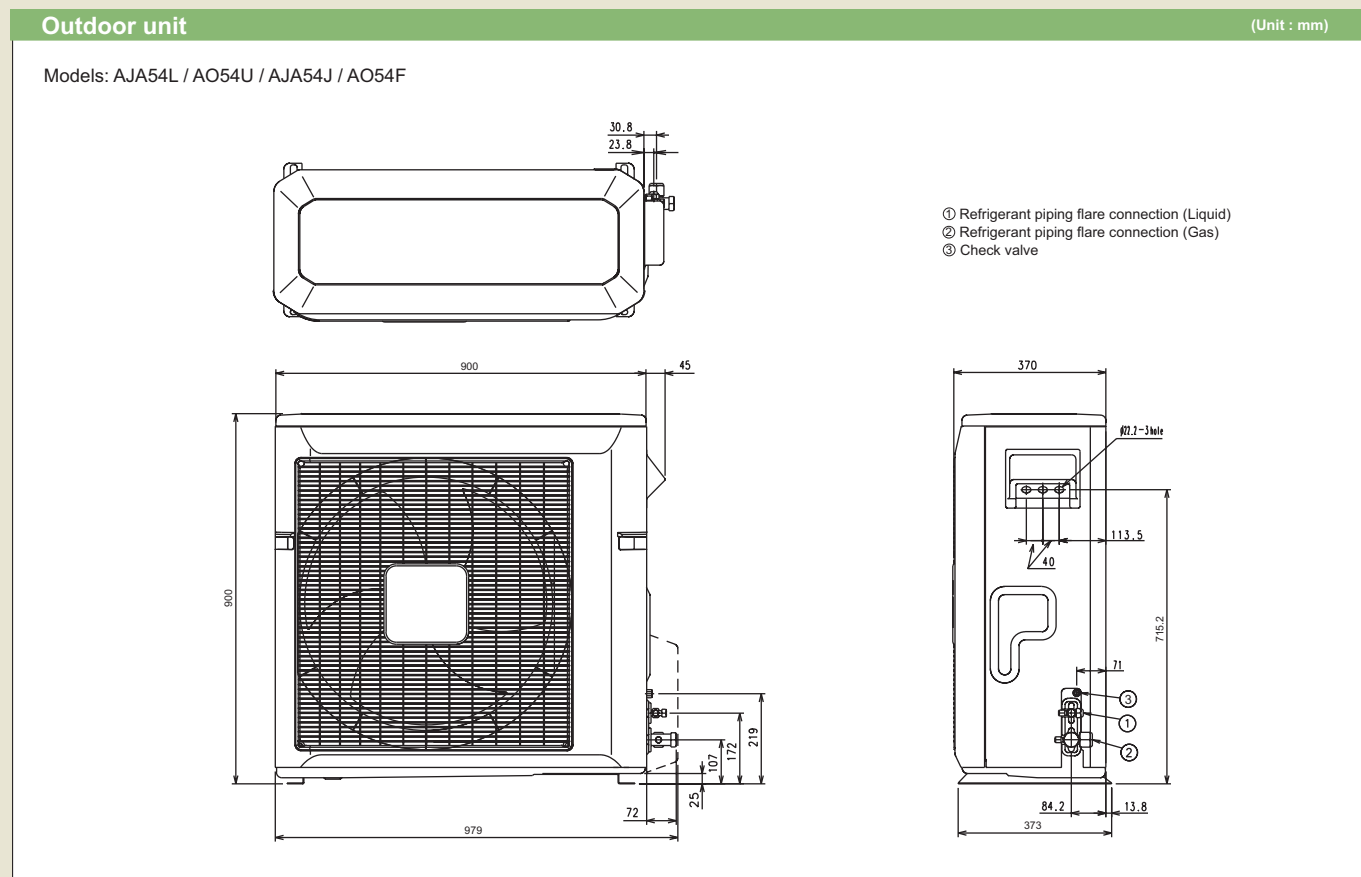

ility and efficient operation

Easy installation Quick and easy to install.

Easy to understand piping and wiring installation

- The wiring work is simple in the connection wiring system one by one.
- The dedicated communication line is unnecessary.
- The electrical work is simple because of single-phase power supply.

System diagram

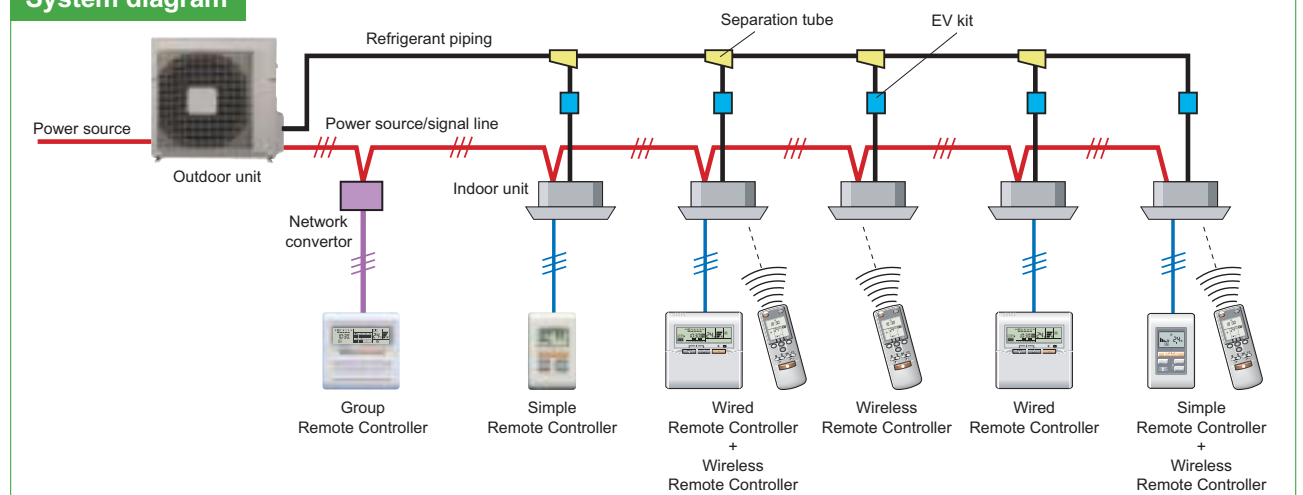

System addressing

- During installation work, system addressing can be performed using the wireless remote controller, thus eliminating manual switch setting.

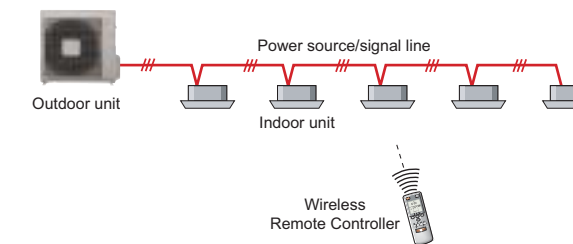

Easier installation of the outdoor unit

- Compact size and lightweight

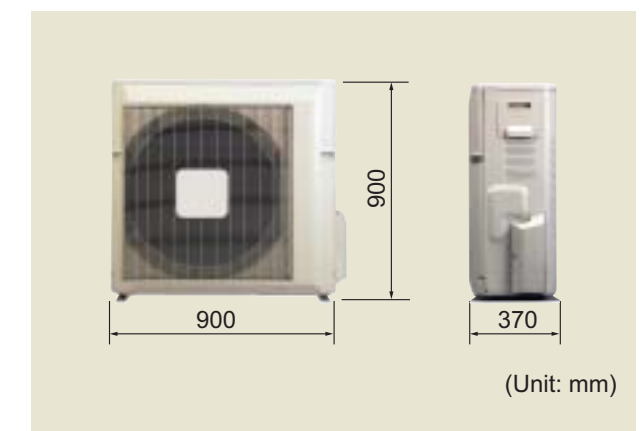

Weight

97kg

The outdoor units is light and compact and easy to handle during installation.

Control system that always provides a pleasant air conditioned environment

Five types of controllers are available to meet the varied needs of the building and the user. Tighter control over the air conditioned environment can be achieved by combining group remote controller which can operate all the indoor units at the same time, a wired remote controller with a weekly or daily schedule, a wireless remote controller and a simple remote controller.

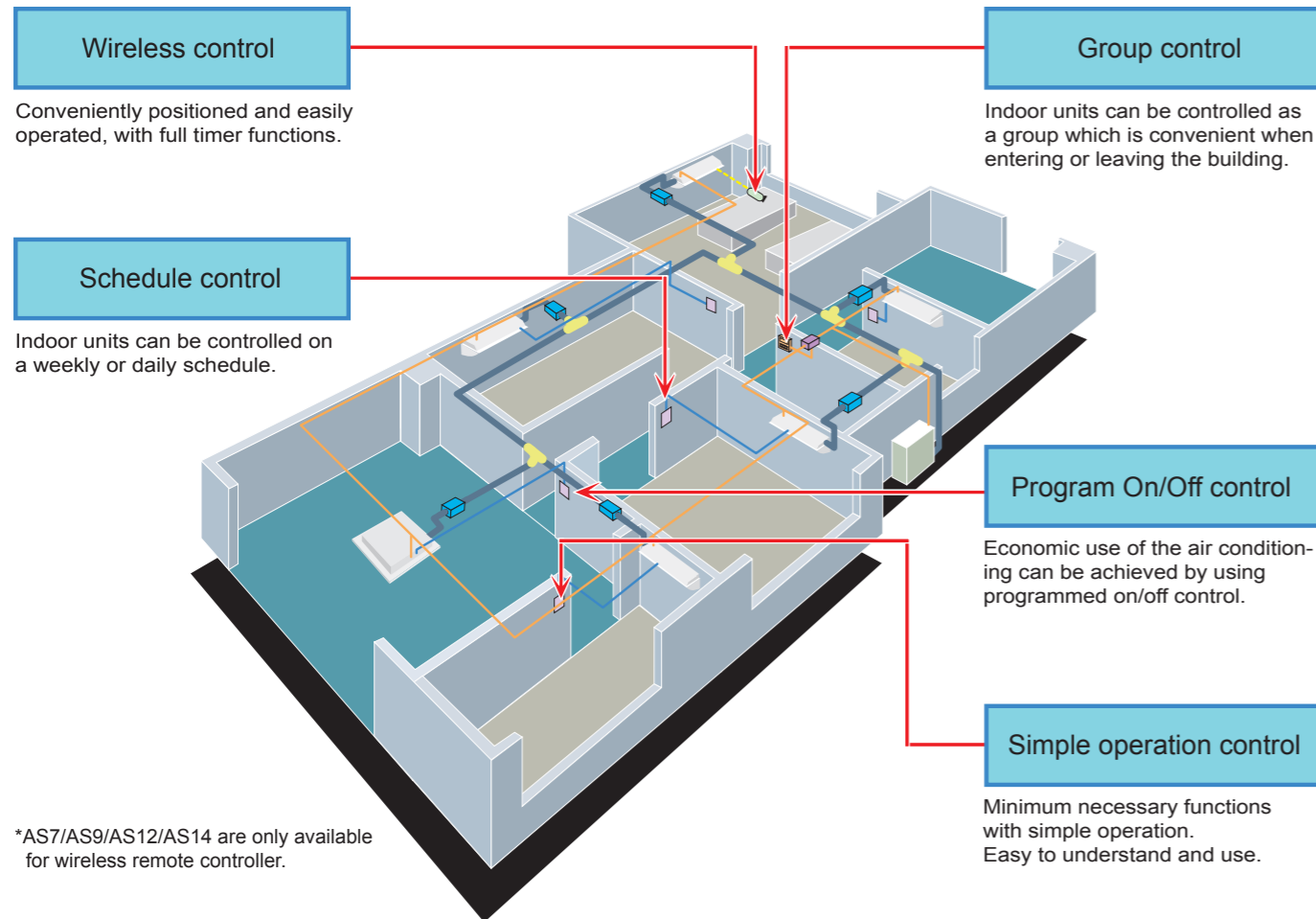

*AS7/AS9/AS12/AS14 are only available for wireless remote controller.

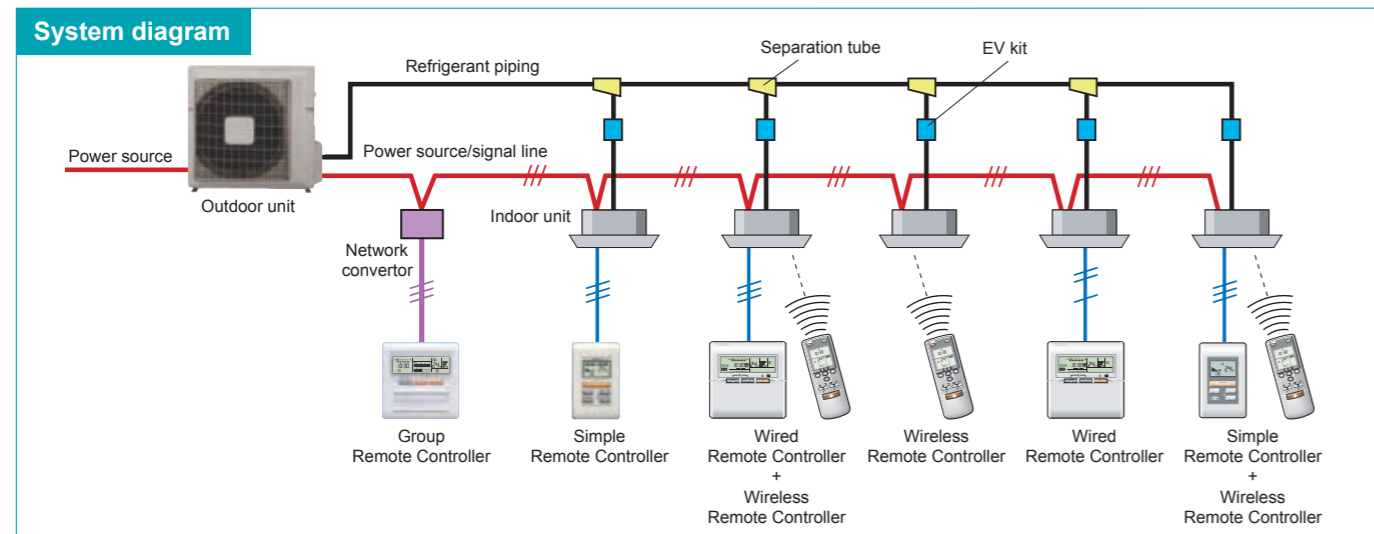

Indoor unit	Compact Duct						Low Static Pressure Duct		Duct				
	Model code	AR7	AR9	AR12	AR14	AR18	AR22	ARXB25	ARXB30	AR25	AR30	AR36	AR45
Model name	ARXA07 LALR	ARXA09 LALR	ARXA12 LALR	ARXA14 LALR	ARXA18 LBLR	ARXA22 LBLR	ARXB25 LATR	ARXB30 LATR	ARY25 UFAAR	ARY30 UFAAR	ARY36 UFAAR	ARY45 UFAAR	
Power source	220-240V, 50Hz												
Cooling capacity	kW	2.15	2.80	3.50	4.00	5.30	6.00	7.05	8.80	7.05	8.80	10.5	12.7
	BTU/h	7,300	9,600	11,900	13,700	18,100	21,100	24,100	30,000	24,100	30,000	36,000	43,500
Heating capacity	kW	2.45	3.10	4.10	4.80	5.60	6.30	7.85	9.10	7.85	9.10	10.7	13.7
	BTU/h	8,400	10,600	14,000	16,400	19,100	21,500	26,800	31,000	26,800	31,000	36,500	47,000
Input power	W	32		49		103	77	155		155		315	
Current	A	0.20		0.24		0.45	0.36	0.70		0.68		1.44	
Maximum current	A	0.24		0.29		0.54	0.40	0.84		0.84		1.84	
Heat exchanger	Plate fin coil												
Air circulation	High	420		620		950	890	1,340		1,200		2,200	
	Med	390		550		790	780	1,090		1,100		2,000	
	Low	360		470		620	670	970		1,000		1,800	
Recommend static pressure	Pa	0 to 40						0 to 80		30 to 160		30 to 180	
Fan type x number	Sirocco x 1						Sirocco x 2						
Fan motor output	W	10		14		52	36	47		77		275	
Noise level (sound pressure)	High	34		33		40	42	33		44		49	
	Med	32		29		35	38	29		42		47	
	Low	31		27		30	34	26		40		45	
Air filter	PP monofilament net (Antibacterial / Deodorization)						Filter : UTD-LF270 (Option) PP honeycomb net, Fungicide Type						
Dimensions (H x W x D)	Net	217 x 663 x 595		217 x 953 x 595		270 x 1,210 x 700							
	Gross	324 x 785 x 686		324 x 1,075 x 686		300 x 1,320 x 790							
Weight	Net	18		25		43							
	Gross	22		29		53							
Pipe size	Diameter	Ø 6.35		Ø 6.35		Ø 6.35	Ø 9.52	Ø 6.35	Ø 9.52				
	Connection method	Flare						Flare					
Drain pipe material	Dia. (mm)	ABS/Outer diameter 26mm / Inner diameter 21.5mm						Steel/Outer diameter 38.1mm / Inner diameter 35.7mm					

Note: Specifications are based on the following conditions.
Cooling: Indoor temperature 27°CDB/19°CWB, and outdoor temperature 35°CDB/24°CWB.
Heating: Indoor temperature of 20°CDB/15°CWB, and outdoor temperature 7°CDB/6°CWB.
Standard static pressure: 0Pa (AR7 to AR22, ARXB25, ARXB30), 100Pa (AR25 to AR45).
Voltage: 230 [V]

AS* : AS (FUJITSU), ASG (GENERAL)

Indoor unit	Compact Wall Mounted				Wall Mounted			
	Model code	AS7	AS9	AS12	AS14	AS18	AS24	AS30
Model name	AS*7 UFADR	AS*9 UFADR	AS*12 UFADR	AS*14 UFADR	AS*18 UFAJR	AS*24 UFAJR	AS*30 UFAJR	
Power source	220-240V, 50Hz							
Cooling capacity	kW	2.15	2.80	3.50	3.80	5.40	6.90	8.00
	BTU/h	7,400	9,600	11,900	13,000	18,400	23,600	27,300
Heating capacity	kW	2.45	3.10	4.10	4.50	5.60	7.80	8.80
	BTU/h	8,400	10,600	14,000	15,400	19,100	26,600	30,000
Input power	W	26	33	40		38	50	60
Current	A	0.15	0.17	0.21		0.18	0.24	0.28
Maximum current	A	0.18	0.21	0.24		0.22	0.29	0.34
Heat exchanger	Plate fin coil							
Air circulation	High	410	500	540		840	950	1,050
	Med	370	450	510		700	800	940
	Low	350	410	480		600	670	780
Fan type x number	Cross flow x 1							
Fan motor output	W	13				38		
Noise level (sound pressure)	High	30	36	39		42	45	48
	Med	27	33	37		39	41	45
	Low	26	30	34		35	37	41
Air filter	PP honeycomb (Antibacterial and Mold proofing)				PP monofilament net (Deodorization, Anti-mold)			
Casing color	White							
Dimensions (H x W x D)	Net	257 x 808 x 187				320 x 1,120 x 220		
	Gross	270 x 850 x 310				348 x 1,240 x 427		
Weight	Net	8				16		
	Gross	10				22		
Pipe	Diameter	Ø 6.35				Ø 9.52		
	Connection method	Flare						
Drain pipe material	Diameter (mm)	With 620mm drain hose, PVC / Outer diameter 16.2-17mm / Inner diameter 12mm				With 670mm drain hose, PVC / Outer diameter 24mm / Inner diameter 17mm		

Note: Specifications are based on the following conditions.
Cooling: Indoor temperature 27°CDB/19°CWB, and outdoor temperature 35°CDB/24°CWB.
Heating: Indoor temperature of 20°CDB/15°CWB, and outdoor temperature 7°CDB/6°CWB.
Voltage: 230 [V]

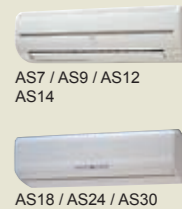

Specifications

AJ*A : AJYA (FUJITSU), AJ*A : AJGA (GENERAL)
AO* : AO (FUJITSU), AOG (GENERAL)

Outdoor unit				AJ*A54LCLR	AJ*A54JCLR	AO*54UJBMR	AO*54FJBMR
Model name							
Power source		Single-phase, 220-240V, 50Hz					
Capacity	Cooling	15.2					
	Heating	16.6	—	16.6	—		
Input power	Cooling	4.75					
	Heating	4.88	—	4.88	—		
Maximum current		30, 25, 20, 15 (The ranges can be selected by setting DIP switch)					
COP	Cooling	3.20					
	Heating	3.40	—	3.40	—		
Heat exchanger fin		Corrosion-resistance (Blue fin)			Hydrophilic coating		
Air circulation		m ³ / h					
Fan type x Number		Propeller x 1					
Fan motor output		W					
Noise level (sound pressure)	Normal operation mode	56					
	Silent operation mode	51					
Compressor	Type	Scroll					
	Driving method	DC inverter					
	Motor output	W					
Refrigerant		R410A					
Refrigerant oil		Synthetic oil (POE oil)					
Casing color		Beige					
Dimensions (H x W x D)	Net	900 x 900 x 370					
	Gross	1,021 x 1,026 x 436					
Weight	Net	97					
	Gross	112					
Safety devices		Fan motor thermal protector, High pressure switch, Low pressure switch, Fuse					
Operation range	Cooling	°C					
	Heating	-20 to 21	—	-20 to 21	—		
Pipe	Diameter	Liquid / Gas	mm				Ø9.52 / Ø19.05
	Max length / Max height difference	m		70 / 30			
		Pipe connection method		Flare			
Connectable indoor units		Maximum 8					
Connectable indoor unit capacity		50% to 150%					

Note: Specifications are based on the following conditions.
Cooling: Indoor temperature 27°CDB/19°CWB, and outdoor temperature 35°CDB/(24°CWB).
Heating: Indoor temperature of 20°CDB/(15°CWB), and outdoor temperature 7°CDB/6°CWB.
Voltage: 230 [V]

AU* : AU (FUJITSU), AUG (GENERAL)

Indoor unit	Compact Cassette						Cassette							
	AU7	AU9	AU12	AU14	AU18	AU20	AU25	AU30	AU36	AU45	AU54			
Model code	AU7	AU9	AU12	AU14	AU18	AU20	AU25	AU30	AU36	AU45	AU54			
Model name	UFAAR	UFAAR	UFAAR	UFAAR	UFAAR	UFARR	UFARR	UFARR	UFASR	UFASR	UFASR			
Power source		220-240V, 50Hz												
Cooling capacity	kW	2.15	2.80	3.60	4.00	5.00	5.70	7.05	8.80	10.5	12.7	14.1		
	BTU/h	7,400	9,600	12,300	13,700	17,100	19,500	24,100	30,000	35,800	43,400	48,100		
Heating capacity	kW	2.45	3.10	4.10	4.50	5.45	5.80	7.85	9.10	10.7	13.7	15.8		
	BTU/h	8,400	10,600	14,000	15,400	18,600	19,800	26,800	31,100	36,500	46,800	53,900		
Input power	W	28		52		50	117	129	142	175	190	219		
Current	A	0.13		0.23		0.22	0.76	0.80	0.84	0.92	0.94	0.95		
Maximum current	A	0.15		0.27		0.26	0.91	0.96	1.00	1.10	1.12	1.14		
Heat exchanger		Plate fin coil												
Air circulation	High	530		580		640	1,030	1,170	1,270	1,500	1,650	1,780		
	Med	480		520		540	850	970	1,070	1,300	1,450	1,550		
	Low	410		460		470	680	770	880	1,100	1,200	1,300		
Fan type x number		Turbo x 1												
Fan motor output		W		10		15	42		90					
Noise level (sound pressure)	High	38		41		44	42		45	48	49	52		
	Med	35		37		38		40	42	44	47	49		
	Low	31		34		35		37	39	41	43	45		
Air filter		PP honeycomb net (Anti-mold)												
FUJITSU grille color		White (UTG-UDYD-W : Option)												
GENERAL grille color		White (UTG-UDGD-W : Option)												
Dimensions (H x W x D)	Net	230 x 570 x 570				246 x 830 x 830				296 x 830 x 830				
	Gross	280 x 710 x 750				385 x 1,045 x 1,015				435 x 1,045 x 1,015				
Weight	Net	18				34				40				
	Gross	23				45				53				
Pipe size	Diameter	Liquid	mm						Ø6.35		Ø9.52			
		Gas	Ø9.52		Ø12.70		Ø15.88		Ø19.05					
	Connection method		Flare											
Drain pipe material		Dia. (mm) PS / Outer diameter 37mm / Inner diameter 32mm				ABS / Outer diameter 37mm / Inner diameter 32mm								

Note: Specifications are based on the following conditions.
Cooling: Indoor temperature 27°CDB/19°CWB, and outdoor temperature 35°CDB/(24°CWB).
Heating: Indoor temperature of 20°CDB/(15°CWB), and outdoor temperature 7°CDB/6°CWB.
Voltage: 230 [V]



AJ*A54L
AO*54U



AJ*A54J
AO*54F



AU7 / AU9 / AU12
AU14 / AU18



AU20 / AU25 / AU30
AU36 / AU45 / AU54

Group remote controller which can operate all the indoor units

Group Remote Controller

UTB-YDB / UTB-GDB [Option]



Group control of indoor units with simple operation

- Up to 8 indoor units can be controlled with a single controller.
- Network Converter (UTR-YGCA) is required to connect Group Remote Controllers to a VRF system.

High performance and compact size

ON/OFF, master control, set temperature and air flow can be controlled / monitored centrally or individually.

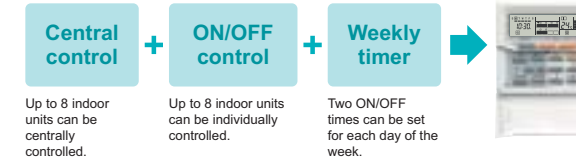

Built-in weekly timers

The weekly timer is provided as a standard function.

1. The timer can be set up for up to 4 times per day. (On / Off, master control, set temperature)
2. Allows separate settings for each day of the week.

ON/OFF switching

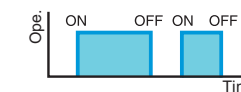

Air conditioning ON/OFF setting corresponding to air conditioning specification needs is possible.

Cooling / Heating switching

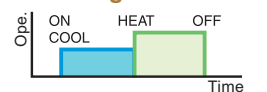

Switching between the cooling mode and heating mode can be set by time.

System configuration

Group/individual control of up to 8 units is possible with a single controller.

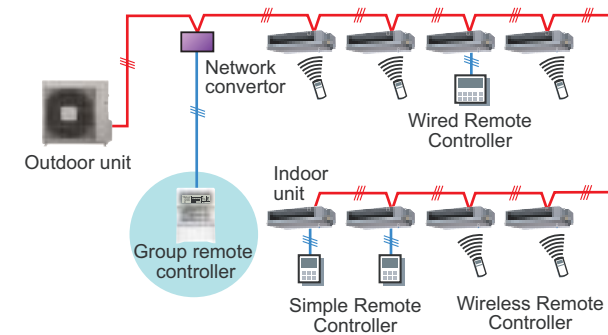

Temperature switching

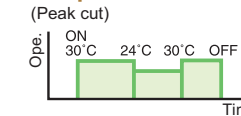

Since peak power cut is performed in a planned way, setting which changes the room temperature linked with time is possible.

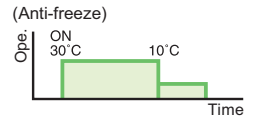

Low temperature heating operation can be set to prevent freezing in cold regions at night, etc.

Stop setting

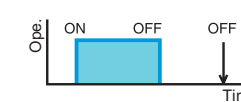

Indoor unit start/stop matched to the air conditioning operation end time is possible.

Specifications

Model	Group Remote Controller		Network Converter
	UTB-YDB/UTB-GDB		UTR-YGCA [Option]
Power Supply	DC 12V		220-240V 50-60Hz
Dimension (mm)	Height	120	86
	Width	120	313
	Depth	17	216
Weight (g)	200		1,900

A controller can be chosen according to user comfortable, easily adjustable air flow

Wired Remote Controller

UTB-YUB / UTB-GUB / UTB-TUB [Option]

Weekly timer and timer function are easily operated.

Dimensions (H x W x D) 120 x 120 x 17

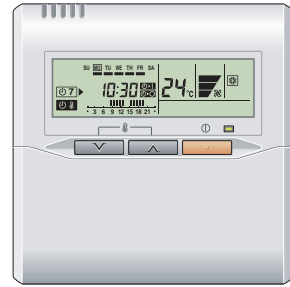

Powerful features and compact size

Wired remote controller, Weekly timer and Setback timer functions are combined in one compact unit.



Remote controller operation combined with easy-to-read LCD and with frequently used buttons arranged to be easy to use.

Two ON/OFF times can be set for each day of the week.

Allows the user to set temperatures for two time spans over the course of each day of the week.

Simple installation

Components are compatible with standard switch boxes. Flat back construction allows equipment to be installed wherever it is needed.

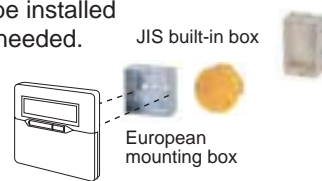

Accurate and Comfortable

Indoor temperature can be detected accurately because a thermo sensor has been added in the body of the wired remote controller. The detecting point in the room can be freely changed with the new type wired remote controller (thermo sensor added) and remote sensor (Option).

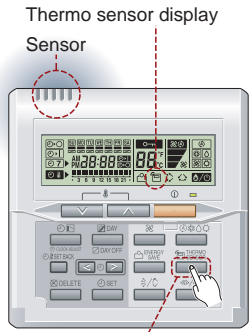

Control button for changing the thermo sensor

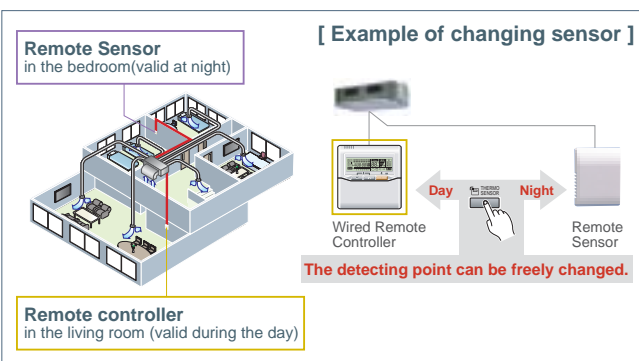

Simple Remote Controller

UTB-YPB / UTB-GPB / UTB-TPB [Option]
UTB-YRA / UTB-GRA / UTB-TRA [Option]

Simple remote controller concentrating on basic operations.

Dimensions (H x W x D mm) 120 x 75 x 14

Remote control + Backlight LCD

*1: Remote control with the minimum required operation buttons.
*2: A simple LCD with the background lighted.



UTB-YPB / UTB-GPB / UTB-TPB
UTB-YRA / UTB-GRA / UTB-TRA
Without master control

Simple operation

- A large Start/Stop button is provided in the centre of the remote controller unit for easy operation.
- The backlight is lit during button operations, and for 10 seconds longer in the operation mode and 5 seconds longer in the stop mode.



Functions

Model	UTB-YPB UTB-GPB UTB-TPB	UTB-YRA UTB-GRA UTB-TRA
Operation		
On/Off	●	●
Fan control	●	●
Master control	●	—
Temp. setting	●	●

Wall Mounted

AS*18UFAJR AS*24UFAJR AS*30UFAJR



Features

Pleasant multi-air flow

Effective air flow within a room is achieved by the unique operation of the power diffuser. The angle of the louvre can be adjusted in six steps to give draught-free air flow.

Wide air flow realized by unique operation of the power diffuser

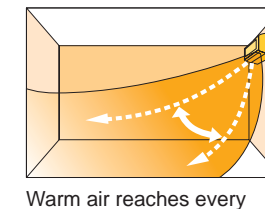
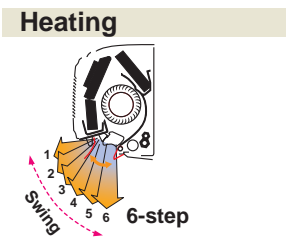
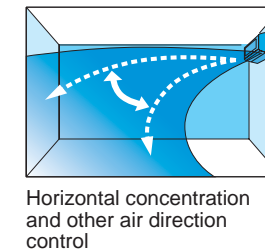
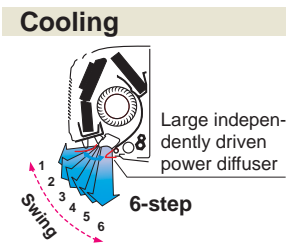

Step Swing

Symmetrical design

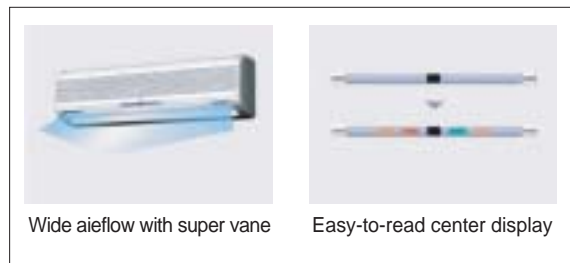

Vertical and horizontal symmetrical design matched to the interior decor

Other functions

Other features include the functions of the existing wall mounted type.

- 2-way draining route
- Double auto swing

Optional parts

Air clean filter (UTR-FA08)

Easy installation

Larger space at base of housing means an extra 15% of piping space.

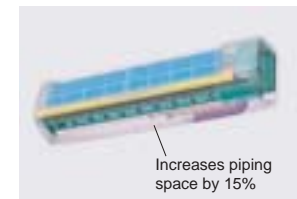

Attractive wall-mounted unit that delivers a needs

Compact Wall Mounted

AS*7UFADR AS*9UFADR AS*12UFADR AS*14UFADR



Features

*AS7/AS9/AS12/AS14 are only available for wireless remote controller.

Symmetrical design

Symmetrical, clean design that suits all interiors.

Compact size

Powerful output in spite of small size

Though the indoor unit is compact, it features a large, high pressure cross fan (90mm diameter) in a centre mounted configuration and a Lambda type heat exchanger to provide plenty of power.

Height	257
Width	808
Depth	187

Unit: mm

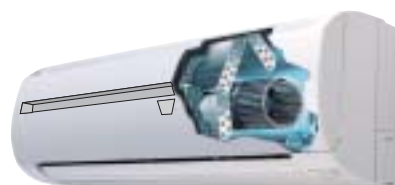

Low noise

Fan speed	dB (A)
HIGH	30
LOW	26

*AS7 model data

Auto swing louvre

The Auto Swing Louvre function ensures that the air direction corresponds to the mode selected.

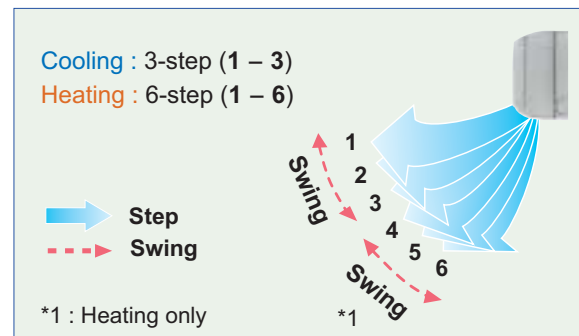

Washable open panel

Cleaning the washable panel removes mould and dust.

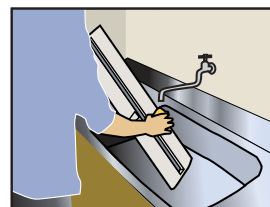

A regular wipe with a dry cloth keeps the casing clean.

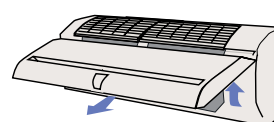

Since the panel is removed and easily washed, it is always clean. Filter cleaning is also simple.

Wireless Remote Controller [Accessory]

Four kinds of timers. Easy operation.

- Wireless remote controller is an accessory of all indoor units.
- An IR Receiver Unit necessary for operation by accessory wireless remote controller is connected to Duct type indoor unit.

Dimensions (H x W x D mm) 158 x 56 x 20

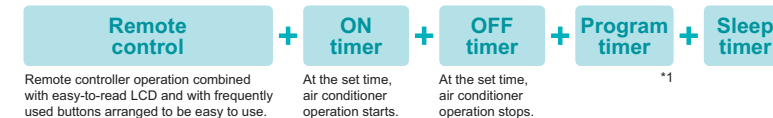

Built-in daily timer

Select from 4 different timer programs : On / Off / Program / Sleep

*1: Program timer / The program timer operates the ON and OFF timer once within a 24 hour period.

*2: Sleep timer / The sleep timer function automatically corrects the set temperature according to the time setting to prevent excessive cooling or heating during sleep hours.

Cooling operation / dry operation

When the sleep timer is set, the set temperature automatically rises 1°C every hour. The set temperature can rise up to a maximum of 2°C.

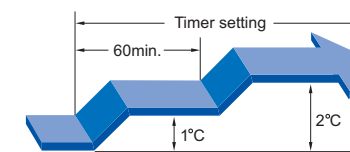

Heating operation

When the sleep timer is set, the set temperature automatically drops 1°C every 30 minutes. The set temperature can drop to a maximum of 4°C.

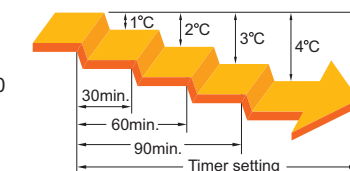

Simple operation

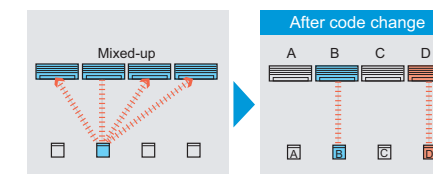

• Code selector switch prevents units from being wrongly switched. (Up to 4 codes can be set.)

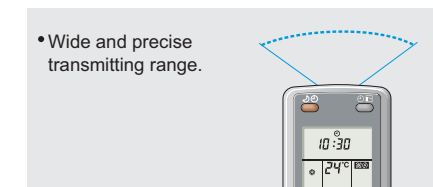

• Wide and precise transmitting range.

External Switch Controller

UTR-YESA [Option]

- On/Off, Temperature, Fan control, and Master control can be switched in combination equipped with the Card-key switch or sensor switch.
- Switching of the air conditioner can be controlled by connecting other sensor switches. *Card-key and other sensor switches are available as field supplied parts.

Dimensions (H x W x D mm) 120 x 75 x 30

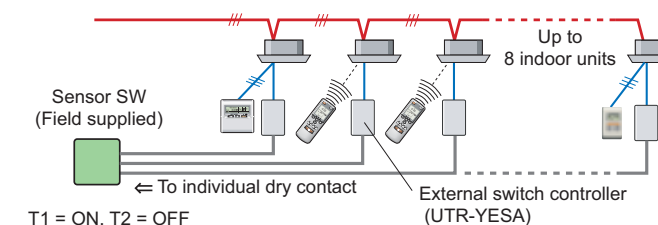
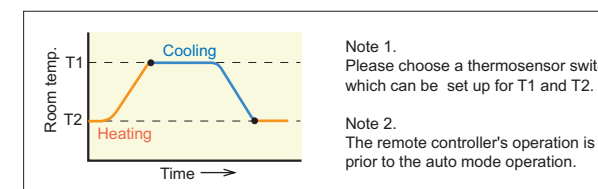

Installation example

- Auto mode operation, which switches the cooling and the heating auto-matically, is enabled by using the sensor switch and external switch controller. In that case, all indoor units run in the same operation mode.



Select to match the capacity and type of the room very low ceilings

Indoor unit line up 7 types 30 models, ranging from 2.15kW to 14.10kW.

Capacity range (kW) ▶	2.15	2.8	3.6	4.0	5.3	5.7	
Type	Model code ▶	7	9	12	14	18	20
Compact Cassette P14	 AU7UFAAR	 AU9UFAAR	 AU12UFAAR	 AU14UFAAR	 AU18UFAAR		
Cassette P15						 AU*20UFARR	
Compact Duct P16	 ARXA07LALR	 ARXA09LALR	 ARXA12LALR	 ARXA14LALR	 ARXA18LALR		
Low Static Pressure Duct P17 <small>Silent Model</small>							
Duct P17							
Compact Wall Mounted P18	 AS*7UFADR	 AS*9UFADR	 AS*12UFADR	 AS*14UFADR			
Wall Mounted P19					 AS*18UFAJR		

AU: AUY(FUJITSU), AUG(GENERAL) *AS*: ASY(FUJITSU), ASG(GENERAL)

Low Static Pressure Duct Silent Model

ARXB25LATR ARXB30LATR

Duct

AR25UFAAR AR30UFAAR
AR36UFAAR AR45UFAAR



*Wireless remote controller and IR receiver unit is supplied with all duct type indoor units.

Features

Low static pressure duct type

- Optimum model for hotels or bedrooms

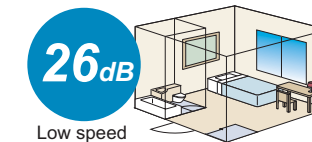

An ultra low-noise model that achieves a quiet interior. Perfect for hotels or bedrooms with limited air duct installation space.

Installation styles

Direct air flow installation can be performed. Air intake system can also be chosen.

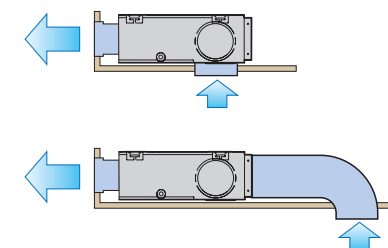

Duct type

- Powerful model with a flexible design

With a powerful motor, appropriate for a wide range of static pressure. Flexible air duct installation is possible in a large space such as an office.

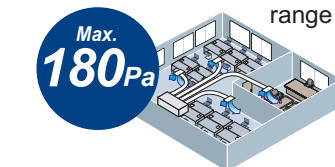

Installation styles

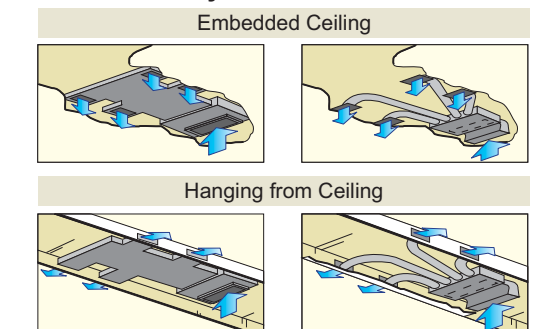

Savings in space and easy installation

Slim compact design allows for easy installation in narrow ceiling space.

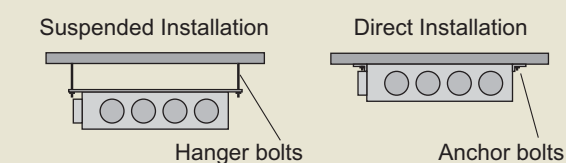
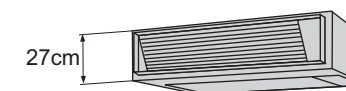

Two-direction drain piping

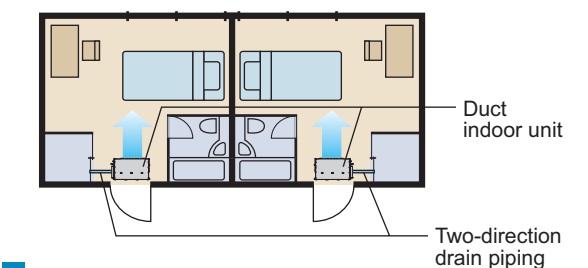

Optional parts

Flange (square)	UTD-SF045T
Flange (round)	UTD-RF204
Long-life filter	UTD-LF270
Remote sensor unit	UTD-RS100

Ultra-slim duct air conditioner for use with

Compact Duct

ARXA07LALR ARXA09LALR ARXA12LALR
ARXA14LALR ARXA18LALR ARXA22LALR



*Wireless remote controller and IR receiver unit is supplied with all duct type indoor units.

Features

Compact and space-saving design

Ultra-slim unit simplifies installation.



Low noise level

These compact duct type units are extremely quiet.

Model	7	9	12	14	18	22
Static pressure (standard/max) Pa	0 / 40					
Air flow volume (high/low) m ³ /h	420/360	620/470	950/620	890/670		
Noise level (Low speed) dB(A)	31	27	30	34		

Easy installation (Universal type)

Slim and compact dimensions allow for ceiling installation or floor standing.

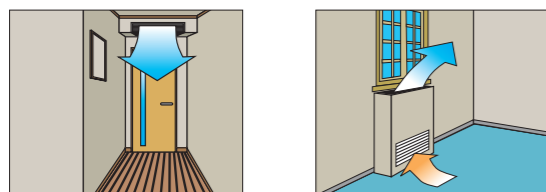

Perfectly housed in ceiling space.

Perfectly housed in the space below a window.

Installation example



Optional parts

Remote sensor unit UTD-RS100
Drain pump unit UTZ-PX1BBA

Two-direction drain piping

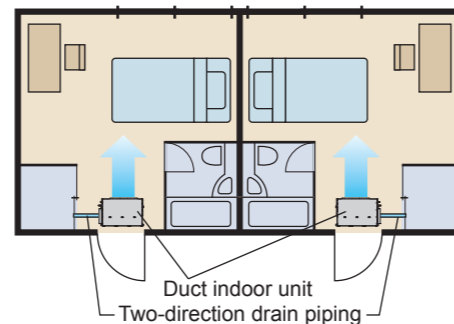

Filter (Accessory)

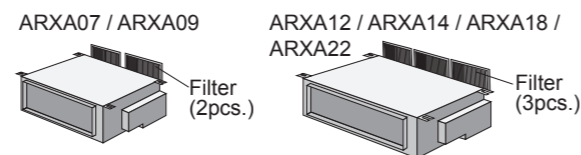

Others

- Air intake from rear or bottom side
- Two direction drain piping

Accessories

	6.0	6.9	7.05	8.8	10.5	12.7	14.1	Wireless Remote Controller	IR Receiver Unit
	22	24	25	30	36	45	54		

Slim and compact cassette, designed for limited ceiling space

Compact Cassette

AU7UFAAR AU9UFAAR AU12UFAAR
AU14UFAAR AU18UFAAR



Features

Compact size

Compact grille fits European ceiling panel (600mm x 600 mm).

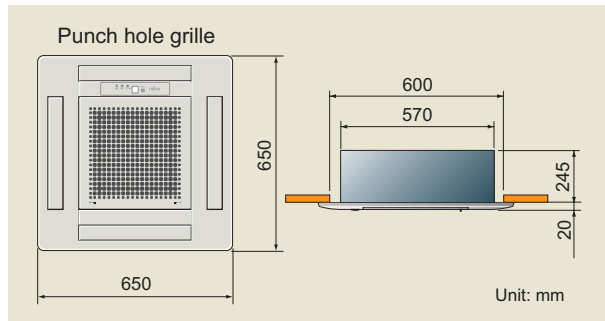

Easy maintenance

Placing all the electrical components inside the unit ensures easy maintenance.

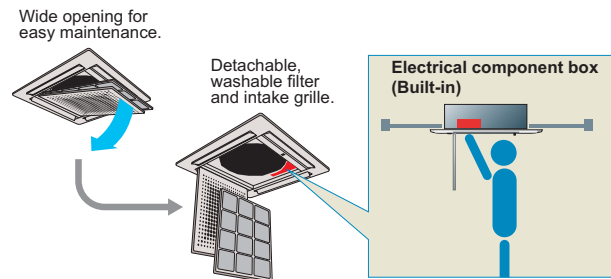

Condensate pump lifts to 400mm

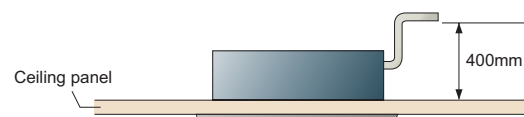

Comfortable air flow

4-step swing: Auto air flow direction and auto swing

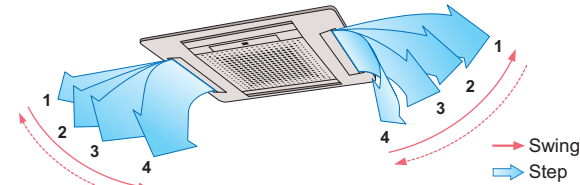

2-4 way air flow system: Select 2-way, 3-way, or 4-way air flow to suit your needs.

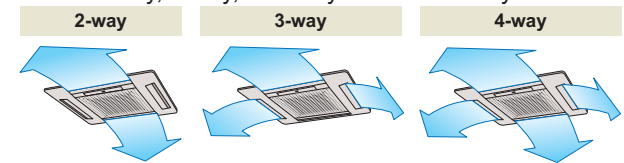

Extremely quiet

Large air flow at reduced noise output achieved by incorporating a large diameter variable pitch turbo fan.

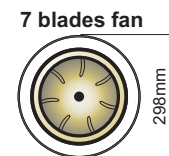

Draught prevention

The angle of the flap can be changed during installation, thereby preventing uncomfortable draughts.

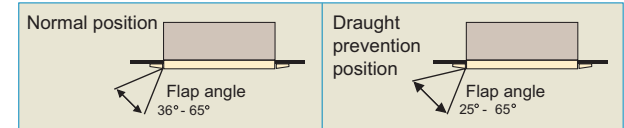

Optional parts

Grille kit UTG-UDYD-W, UTG-UDGD-W

Cassette Slim Type

AU*20UFARR AU*25UFARR AU*30UFARR

Cassette

AU*36UFASR AU*45UFASR
AU*54UFASR



Features

Flexible installation

Compact body ensures space saving installation. A slender fit option is available where ceiling void space is limited.

	Standard setting	Slender setting
	Ha	Hb
AU20 / AU25 / AU30	235	200
AU36 / AU45 / AU54	285	250

Easy maintenance

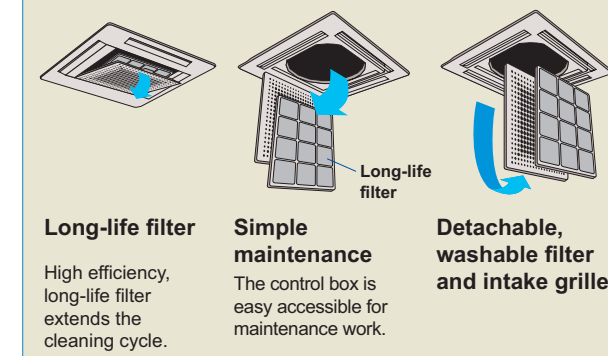

Condensate pump lifts to 800mm



Comfortable air flow

4-step swing

Auto air flow direction and auto swing

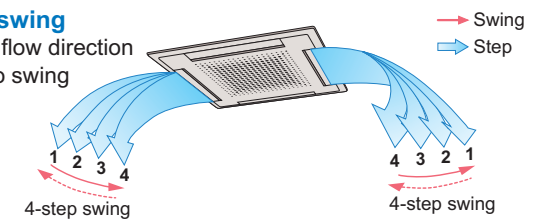

2-4 way air flow system

Select 2-way, 3-way or 4-way air flow to suit your needs.

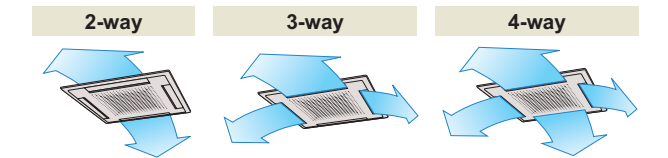

Wide air flow

Unit louvre distributes the outlet air flow further in the horizontal direction.

Duct connection hole opening

Fresh air can be introduced through this opening.

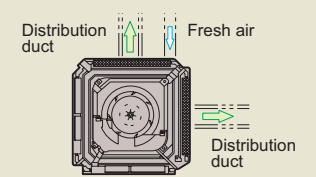

Conditioned air can be distributed by means of a distribution duct.

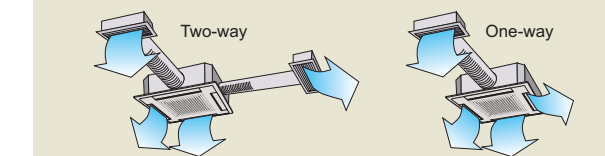

Improved noise level and air distribution

Noise output has been dramatically lowered.

- Improved turbo fan shape (aerodynamic design)
- Expanded air distribution
- Low internal resistance
- Moulded fan motor

Draught prevention

The angle of the flap can be changed during installation, thereby preventing uncomfortable draughts.

