

PWN

Ducted units technical manual

GB

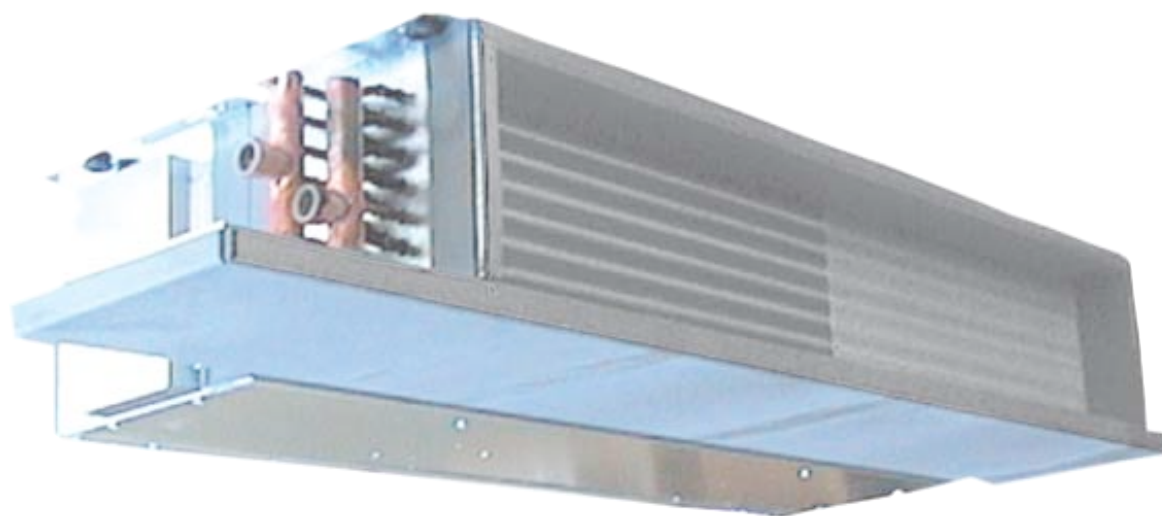

2,5 kW - 10 kW

CE

COMPANY
WITH QUALITY SYSTEM
CERTIFIED BY DNV
=ISO 9001/2000=

INDICE

1 **Generalità** pag. 3

2 **Caratteristiche costruttive** pag. 3

3 **Accessori disponibili** pag. 3

4 **Caratteristiche tecniche nominali** pag. 4

5 **Caratteristiche di ventilazione** pag. 5

5.1 Accessori: perdite di carico lato aria pag. 6

6 **Livelli di potenza sonora** pag. 7

7 **Prestazioni**

7.1 **Resa in raffreddamento** pagg. 8/9

7.2 **Resa in riscaldamento** pagg. 10/11

7.3 **Resa in riscaldamento MDF** pag. 12

8 **Avvertenze di installazione** pag.12

9 **Caratteristiche dimensionali** pagg. 13

10 **Schemi elettrici di collegamento** pagg. 14/19

11 **Accessori** pagg. 20/23

DECLARATION OF CONFORMITY 

Galletti S.p.A., whose main office is in Via Romagnoli, 12/a Bentivoglio (BO) - Italy, hereby declares, under its sole responsibility, that the **PWN** duct units, devices for air conditioning systems, suitable for duct type air distribution installations, conform to the specifications of **EEC Directives 73/23, 89/392, 91/368, 93/44, 93/68, 98/37** and **89/336**.

Bologna, 08.03.2005

Luigi Galletti

President



OPERATING LIMITS

Thermal carrier: water

Water temperature: + 5°C ÷ +95°C

Air temperature: -20°C ÷ + 43°C

Power supply: 230 V +/-10 %

Maximum operating pressure: 10 bar

1 MAIN FEATURES

The range of PWN, ducted units, has been designed for conditioning rooms that require the false ceiling installation with medium head (60Pa) particularly versatile and silent.

Proposed in 9 models with air flows from 400 to 1200 m³/h, available pressure head 60 Pa and cooling capacity from 2,8 to 10,3 kW.

The special constructive solution allows to expand the basic model thanks to a wide range of modular accessories and permit the installation of PWN units in shopping centre, hotel rooms, meeting rooms, etc..

The peculiar constructive features are:

- > Horizontal installation in false ceiling
- > Reduced height (240 mm) on the whole range
- > Standard 7 speed motors connected in the main terminal board
- > Big capacity condensate drip tray which is extended beyond the hydraulic connections allowing the collection of condensate also from the control valves. The decentralized positioning reduces the installation spaces remarkably.
- > anti-vibration damper on fixing slots to avoid the transmission of vibration to the supporting structure.
- > Possibility of connection to the circular flexible ducts (φ200 mm) or to rectangular ducts
- > The wide range of accessories to respond effectively to any installation requirements.:
 - electromechanical and microprocessor wall-mounted controls;
 - possibility of connection to the ERGO-nets;
 - accessories for air duct connection: air inlet and outlet cassettes, inlet and outlet grilles;
 - inlet plenum;
 - air inlet and outlet silencer
 - additional heat exchanger for post-heating in 4 pipe units
 - additional electric heating elements

2 CONSTRUCTIVE FEATURES

- > Bearing structure made of galvanized steel, duly insulated with anticondensing material and self-extinguishing class 1. The unit is completed by the following:
 - big capacity condensate drip tray for the collection of condensate from the heat exchanger and from any eventual control valves;
 - wiring box positioned on the hydraulic connection side to reduce the installation spaces;
 - slots for fast mounting.
- > Dual intake centrifugal fans made of aluminium, forward blade profile, with statically and dynamically balanced impellers , coupled directly to the electric motor.
- > 7 speed electrical motor, with permanent fitted condenser and thermal protection, mounted on vibration damping support.
- > High efficiency heat exchanger with 3,4 or 6 rows, made of copper tube and aluminium fins secured to the tubes by mechanical expansion. It is fitted with brass manifolds and air valves . The heat exchanger, usually supplied with left hand water connections, can be turned by 180°.
- > Air filter made of acrylic fibre, filter class EU2, positioned on air inlet, removable from the bottom drawer.

3 AVAILABLE OPTIONS

CONTROL PANELS AND THERMOSTATS	
CD	Recess wall-mounted speed switch
CDE	Wall-mounted speed selector
TD	Wall-mounted control with speed selector, electromechanical thermostat and summer/winter selector
TDC	Wall-mounted control with speed selector and electromechanical thermostat selector,
TD4T	Wall-mounted control with speed electromechanical thermostat and summer winter selector for 2/4 pipe systems with valves
MICROD	Microprocessor wall-mounted control for the automatic control of the fan-coil
MICROPROD	Microprocessor wall-mounted control for the automatic control of the fan-coil, valves and electric heater
MICRONET	Microprocessor control ERGO solution
SW	Water temperature electronic probe for MICROD and MICROPROD
TC	Fan stop thermostat: electromechanical thermostat for minimum water temperature during heating mode
I PM	Power interface for MICROD and MICROPROD
T A	Electromechanical room thermostat
T A 2	Electromechanical room thermostat with summer/winter selection
CSD	Wall-mounted control for proportional opening and closing of the motor driven air intake louver
KP	Power interface for connecting in parallel up to 4 fan coil units to one control
PLENUM AND CONNECTIONS FOR INTAKE AND DELIVERY	
PMA	Intake and delivery plenum, not insulated with spigot φ 200
PMAC	Intake and delivery plenum, insulated with spigot φ 200
PAF	Front intake plenum, not insulated with spigot φ 200
RD	Straight connection for intake/delivery, not insulated
RDC	Straight connection for intake/delivery, insulated
R90	90° connection for intake/delivery, not insulated
R90C	90° connection for intake/delivery, insulated
FLEXIBLE DUCTS - CAPS	
TFA	Not insulated flexible ducts, φ 200
TFM	Insulated flexible ducts, φ 200
TP	Plastic caps φ 200
AIR INLET AND OUTLET PLENUM BOX	
CA	Air inlet plenum box with double row grille
CAF	Air inlet plenum box with double row grille and filter G2
CM	Insulated air outlet plenum box with 2 way grille
INTAKE AND DELIVERY SOUND ATTENUATOR	
SIL	sound attenuator for intake/delivery
AIR INLET AND OUTLET GRILLES	
GM	Aluminium air outlet grille with double row fins and frame
GA	Aluminium air outlet grille with frame
3-WAY VALVE WITH ON/OFF ELECTROTHERMAL MOTOR	
VK	3-way valve with ON/OFF electrothermal motor and hydraulic kit
KSC	Condensate removal kit
ADDITIONAL HEAT EXCHANGER ASSEMBLY	
MDF	Additional heat exchanger assembly for hot water operation
ADDITIONAL ELECTRIC HEATER	
RE	Electric heating element complete with installation kit, safety devices, power relay box, heat resistant grilles
FRESH AIR INTAKE WITH LOUVER	
SM	Motor driven external air intake louver

4 RATED TECHNICAL DATA

PWN		13	14	16	23	24	26	33	34	36
Rated air flow	m ³ /h	400	400	400	800	800	800	1200	1200	1200
Available external static pressure	Pa	71	71	71	65	65	65	59	59	59
Power supply	V - ph . Hz	230 - 1 - 50								
Max. power input	W	117	117	117	200	200	200	325	325	325
Max current absorbed	A	0,56	0,56	0,56	1,10	1,10	1,10	1,40	1,40	1,40
Total cooling capacity	kW	2,61	3,14	3,49	5,08	5,45	6,47	7,57	8,67	10,34
Sensible cooling capacity	kW	1,88	2,16	2,34	3,60	3,87	4,40	5,23	5,96	6,90
Water flow	l/h	448	539	598	873	936	1111	1299	1488	1774
Water pressure drop	kPa	8	14	11	15	8	14	21	21	26
Heating capacity	kW	5,47	6,01	6,47	10,31	11,39	12,28	15,00	16,90	18,80
Water flow	l/h	480	527	567	904	999	1077	1319	1479	1647
Water pressure drop	kPa	7	10	8	12	7	10	16	15	18
MDF heating capacity (4 pipe system)	kW	3,14	3,14	3,14	5,99	5,99	5,99	12,80	12,80	12,80
MDF water flow	l/h	275	275	275	526	526	526	1123	1123	1123
MDF water pressure drop	kPa	3	3	3	5	5	5	8	8	8
Standard coil - number of rows	n°	3	4	6	3	4	6	3	4	6
Standard coil - water connection	inches	3/4	3/4	3/4	3/4	3/4	3/4	3/4	3/4	3/4
Standard coil - water content	liters	1,1	1,5	2,2	1,6	2,1	3,2	2,1	2,8	4,2
MDF coil - number of rows	n°	1	1	1	1	1	1	2	2	2
MDF coil - water connections	inches	3/4	3/4	3/4	3/4	3/4	3/4	1	1	1
MDF coil - water content	liters	0,4	0,4	0,4	0,6	0,6	0,6	1,7	1,7	1,7
Electric heating element power input	kW	2	2	2	3	3	3	3	3	3
Electric heater current absorbed	A	8,7	8,7	8,7	10,9	10,9	10,9	13,0	13,0	13,0
Electric heater power input	V - ph - Hz	230 - 1 - 50								
Sound power level	dB A	58	58	58	60	60	60	69	69	69

The aforesaid performance is related to the following conditions.

Air flow:

- related to the rated usable static pressure, at max. speed (7)

Cooling:

- rated air flow
- water inlet temperature 7°C
- water outlet temperature 12°C
- air temperature with dry bulb 27°C
- air temperature with moist bulb 19°C (47% relative humidity)

Heating:

- rated air flow
- water inlet temperature 70°C
- water outlet temperature 60°C
- air temperature 20°C

5 VENTILATION FEATURES

Psu Available static pressure

Qa Air flow

Vr Fan speed:

7 = high

1 = low

		Psu (Pa)											
		Vr	Qa	0	10	20	30	40	50	60	70	80	90
PWN 1	1	m ³ /h	269	224	180	136	93	-	-	-	-	-	-
	2	m ³ /h	314	271	230	190	150	112	73	-	-	-	-
	3	m ³ /h	348	313	277	240	200	158	113	-	-	-	-
	4	m ³ /h	404	368	332	296	260	225	189	154	119	84	-
	5	m ³ /h	479	442	405	368	332	297	261	226	191	157	-
	6	m ³ /h	565	528	491	454	418	381	345	310	274	239	-
	7	m ³ /h	665	629	592	555	518	480	442	403	363	323	-
PWN 2	1	m ³ /h	413	363	313	265	218	172	127	-	-	-	-
	2	m ³ /h	508	462	416	371	327	283	240	198	155	114	-
	3	m ³ /h	618	578	538	497	455	413	371	328	284	240	-
	4	m ³ /h	753	720	686	651	614	576	535	493	447	399	-
	5	m ³ /h	860	818	776	733	688	644	598	551	503	454	-
	6	m ³ /h	949	909	866	823	778	732	684	633	581	526	-
	7	m ³ /h	1125	1075	1030	981	930	878	825	770	714	656	-
PWN 3	1	m ³ /h	832	756	676	590	499	400	292	-	-	-	-
	2	m ³ /h	920	844	763	676	583	480	364	230	-	-	-
	3	m ³ /h	1025	951	873	790	700	602	494	370	222	-	-
	4	m ³ /h	1212	1123	1031	932	827	715	592	455	300	-	-
	5	m ³ /h	1439	1347	1252	1152	1048	938	822	697	563	416	-
	6	m ³ /h	1653	1564	1471	1372	1268	1156	1037	906	760	593	-
	7	m ³ /h	1842	1746	1645	1539	1427	1310	1183	1048	899	734	-

Note

For the precise calculation of the performances, with air flow rate and available static pressure out of the nominal conditions, please refer to the Galletti selection software.

5 VENTILATION FEATURES

5.1 ACCESSORIES: AIR PRESSURE DROP

Legend:

Qa Air flow

ΔPa Air pressure drop

PWN 1														
Qa [m³/h]		100	150	200	250	300	350	400	450	500	550	600		
PMA	ΔPa (Pa)	1	1	2	2	4	5	6	7	9	10	12		
PAF	ΔPa (Pa)	1	1	2	2	4	5	6	7	9	10	13		
R90	ΔPa (Pa)	-	-	-	-	1	1	1	2	2	2	3		
SIL	ΔPa (Pa)	-	-	-	-	1	1	1	2	2	2	3		
GM	ΔPa (Pa)	-	-	-	-	1	1	1	2	2	2	3		
GA	ΔPa (Pa)	1	1	1	1	2	3	4	4	6	6	8		
SM	ΔPa (Pa)	-	1	1	1	2	2	2	2	3	3	5		
MDF	ΔPa (Pa)	1	1	1	1	2	2	3	3	5	5	6		
PWN 2														
Qa [m³/h]		300	400	500	600	700	800	900	1000					
PMA	ΔPa (Pa)	1	3	4	6	7	10	12	15					
PAF	ΔPa (Pa)	1	3	4	6	8	10	13	15					
R90	ΔPa (Pa)	-	1	1	2	2	2	3	4					
SIL	ΔPa (Pa)	-	1	1	2	2	2	3	4					
GM	ΔPa (Pa)	-	1	1	2	2	3	3	4					
GA	ΔPa (Pa)	1	2	2	4	4	6	8	9					
SM	ΔPa (Pa)	-	1	1	2	2	3	5	5					
MDF	ΔPa (Pa)	-	1	1	2	2	3	5	5					
PWN 3														
Qa [m³/h]		400	500	600	700	800	900	1000	1100	1200	1300	1400	1500	1600
PMA	ΔPa (Pa)	1	2	2	3	3	5	5	7	8	9	10	13	13
R90	ΔPa (Pa)	-	1	1	1	1	2	2	2	3	4	4	5	5
SIL	ΔPa (Pa)	-	1	1	1	1	2	2	2	3	4	4	5	5
GM	ΔPa (Pa)	-	1	1	1	1	2	2	2	3	4	4	5	5
GA	ΔPa (Pa)	1	2	2	3	3	5	5	6	7	7	10	12	13
SM	ΔPa (Pa)	1	1	1	2	2	3	3	4	4	5	6	7	8
MDF	ΔPa (Pa)	1	1	2	2	2	4	4	5	6	7	8	10	10

The air pressure drops here below reported are independent from the size of the unit, but specific of the optional considered.

Qa [m³/h]		400	500	600	700	800	900	1000	1100	1200	1300	1400	1500	1600
TFA - TFM	ΔPa (Pa)	1	1	2	3	4	6	7	9	11	13	15	17	20
CA2	ΔPa (Pa)	1	3	5	8	11	15	20	25	31	37	44	-	-
CA3	ΔPa (Pa)	-	-	1	2	3	5	7	9	12	15	19	23	27
CAF2	ΔPa (Pa)	4	8	12	17	22	29	36	44	53	62	72	-	-
CAF3	ΔPa (Pa)	2	4	5	8	10	13	17	20	24	29	33	39	44
CM1	ΔPa (Pa)	13	24	37	53	73	-	-	-	-	-	-	-	-
CM2	ΔPa (Pa)	1	1	2	3	5	6	7	9	11	13	16	-	-
CM3	ΔPa (Pa)	-	-	1	1	1	1	2	2	3	3	4	5	5

6 SOUND POWER LEVELS FOR OCTAVE BAND

Psu
Lw
Lwa

Available static pressure
Octave sound power level
A-weighted sound power

Vr Fan speed:
1 = low
7 = high

	Lw	PWN 1										PWN 2										PWN 3									
		125 Hz	250 Hz	500 Hz	1 kHz	2 kHz	4 kHz	8 kHz	LwA	dB/A	125 Hz	250 Hz	500 Hz	1 kHz	2 kHz	4 kHz	8 kHz	LwA	dB/A	125 Hz	250 Hz	500 Hz	1 kHz	2 kHz	4 kHz	8 kHz	LwA	dB/A			
Global	1	35	38	34	31	26	15	17	36	37	41	37	30	20	11	14	37	46	49	51	48	46	44	45	44	41	33	24	-		
Suction	1	33	34	30	27	20	10	14	-	35	37	33	26	15	6	11	-	44	46	47	44	46	44	41	33	24	-				
Delivery	1	31	35	31	28	23	13	15	-	33	38	34	27	18	9	12	-	42	46	47	45	46	44	44	36	25	-				
Irradiate	1	18	20	26	14	17	-	-	-	20	23	29	13	12	-	-	-	29	31	42	31	31	38	20	11	-					
Global	2	39	41	38	35	30	17	18	40	41	45	43	36	30	17	15	43	51	50	52	49	50	47	39	28	54					
Suction	2	37	38	34	31	24	13	14	-	39	42	38	32	24	12	11	-	49	47	48	45	47	42	34	25	-					
Delivery	2	35	38	35	32	27	15	15	-	37	42	39	33	27	15	12	-	47	47	49	47	47	45	36	26	-					
Irradiate	2	22	23	30	18	22	-	-	-	24	28	34	19	21	-	-	-	34	33	44	32	33	39	21	11	-					
Global	3	41	44	41	38	34	23	19	43	45	49	47	41	36	25	16	47	50	53	54	51	50	47	31	28	56					
Suction	3	39	40	37	34	28	18	15	-	43	46	43	37	31	21	13	-	48	49	50	48	44	44	36	27	-					
Delivery	3	37	41	38	35	31	21	16	-	41	46	43	38	34	23	14	-	46	50	51	49	47	47	39	28	-					
Irradiate	3	24	26	32	21	25	5	2	-	28	31	38	24	28	7	-	-	33	35	46	34	41	41	23	14	-					
Global	4	44	46	44	41	37	27	20	46	46	52	52	45	41	32	21	52	52	55	56	54	51	50	41	31	58					
Suction	4	41	43	40	37	32	23	16	-	44	49	48	42	36	28	17	-	50	51	52	50	45	45	39	30	-					
Delivery	4	39	43	40	38	35	25	17	-	42	49	49	43	39	30	18	-	48	52	53	51	49	49	41	31	-					
Irradiate	4	27	28	35	24	29	10	3	-	29	35	43	28	33	14	4	-	35	37	47	37	43	43	26	17	-					
Global	5	47	50	48	44	42	34	23	50	49	55	54	47	44	34	24	54	58	60	61	60	56	56	49	41	64					
Suction	5	45	46	43	41	37	29	19	-	46	51	50	44	38	30	20	-	56	57	57	57	51	51	44	37	-					
Delivery	5	43	47	44	42	40	32	21	-	44	52	51	45	41	32	21	-	54	57	58	58	54	54	47	39	-					
Irradiate	5	30	32	39	27	34	16	6	-	32	37	45	30	36	17	7	-	41	43	52	43	48	48	31	24	-					
Global	6	50	53	51	48	46	36	25	52	52	56	55	50	47	39	29	56	61	64	63	63	60	56	53	46	67					
Suction	6	48	50	47	44	41	31	21	-	50	52	51	46	41	35	25	-	59	61	61	59	54	54	48	42	-					
Delivery	6	46	50	48	46	44	34	23	-	48	53	52	47	44	37	27	-	57	61	60	60	57	57	51	43	-					
Irradiate	6	33	35	42	31	38	18	8	-	35	38	46	33	38	22	12	-	44	47	55	46	51	35	29	-						
Global	7	54	57	55	53	51	45	36	58	55	59	59	54	52	46	37	60	63	67	65	64	61	55	49	69						
Suction	7	52	54	51	49	45	40	32	-	53	56	55	50	46	42	33	-	61	63	61	61	56	51	45	45	-					
Delivery	7	50	54	52	50	48	43	33	-	51	57	55	52	49	44	34	-	59	64	62	62	59	53	46	46	-					
Irradiate	7	37	40	47	36	43	27	19	-	38	42	50	37	43	28	20	-	46	49	57	47	53	38	32	32	-					

7 PERFORMANCES

7.1 COOLING CAPACITY

Tbs₁ Inlet air temperature D.B.
Tbu₁ Inlet air temperature W.B.
Tw₁ Inlet water temperature
Tw₂ Outlet water temperature
Qa Air flow

PFT Total cooling capacity
PFS Sensible cooling capacity
Qw Water flow rate
ΔPw Pressure drop on water side

Tbs₁ / Tbu₁ (UR₁)	°C	25 / 18 (51%)															
Tw₁ / Tw₂	°C	6/11				7/12				8/13				9/14			
	Qa	PFT	PFS	Qw	Δpw	PFT	PFS	Qw	Δpw	PFT	PFS	Qw	Δpw	PFT	PFS	Qw	Δpw
	m ³ /h	kW	kW	l/h	kPa	kW	kW	l/h	kPa	kW	kW	l/h	kPa	kW	kW	l/h	kPa
PWN 13	300	1,90	1,35	326	4	1,59	1,23	273	3	1,41	1,15	242	3	1,23	1,08	211	2
	400	2,49	1,75	427	7	2,13	1,61	366	5	1,71	1,44	294	4	1,40	1,33	240	3
	500	3,02	2,12	517	10	2,61	1,96	448	8	2,15	1,77	368	5	1,76	1,76	303	4
PWN 14	300	2,32	1,56	398	8	2,06	1,44	353	6	1,76	1,32	302	5	1,46	1,20	250	3
	400	3,02	2,03	518	13	2,69	1,89	461	10	2,32	1,73	398	8	1,89	1,56	325	6
	500	3,67	2,47	630	18	3,27	2,30	561	15	2,83	2,12	487	11	2,34	1,92	402	8
PWN 16	300	2,54	1,67	436	6	2,27	1,55	390	5	2,00	1,43	344	4	1,77	1,34	304	3
	400	3,36	2,21	576	10	3,02	2,06	518	8	2,64	1,89	453	7	2,19	1,71	377	5
	500	4,14	2,74	710	15	3,73	2,55	639	12	3,27	2,35	561	10	2,75	2,14	473	7
PWN 23	600	3,81	2,65	653	9	3,30	2,44	566	7	2,70	2,21	464	5	2,17	2,17	372	3
	800	4,87	3,37	834	14	4,25	3,12	729	11	3,56	2,85	611	8	2,71	2,53	465	5
	1000	5,83	4,02	1000	19	5,10	3,73	875	15	4,30	3,42	739	11	3,38	3,07	581	7
PWN 24	600	3,87	2,74	663	4	3,28	2,50	562	3	2,91	2,35	499	3	2,53	2,20	434	2
	800	5,18	3,61	889	7	4,41	3,29	757	5	3,36	2,87	577	3	2,87	2,69	493	2
	1000	6,36	4,38	1091	10	5,48	4,02	940	8	4,45	3,61	763	5	3,68	3,68	632	4
PWN 26	600	4,77	3,18	817	8	4,23	2,94	727	7	3,62	2,68	622	5	3,05	2,45	523	4
	800	6,23	4,15	1069	13	5,56	3,86	955	11	4,83	3,55	829	9	3,97	3,20	681	6
	1000	7,60	5,07	1304	19	6,80	4,72	1167	16	5,92	4,35	1017	12	4,93	3,95	847	9
PWN 33	1000	6,25	4,25	1072	15	5,47	3,93	939	12	4,60	3,59	790	9	3,54	3,18	607	5
	1200	7,26	4,91	1245	19	6,37	4,55	1093	15	5,39	4,16	926	11	4,26	3,73	732	7
	1400	8,20	5,51	1406	24	7,21	5,11	1237	19	6,13	4,69	1052	14	4,90	4,22	841	9
PWN 34	1000	7,12	4,80	1220	15	6,29	4,45	1080	12	5,38	4,08	923	9	4,28	3,64	736	6
	1200	8,33	5,61	1428	19	7,38	5,21	1267	16	6,34	4,78	1089	12	5,15	4,31	884	8
	1400	9,48	6,37	1626	24	8,41	5,92	1443	19	7,24	5,44	1244	15	5,93	4,93	1019	10
PWN 36	1000	8,43	5,53	1446	19	7,61	5,15	1306	15	6,71	4,76	1153	12	5,69	4,33	979	9
	1200	9,97	6,54	1711	25	9,01	6,10	1546	21	7,96	5,64	1367	17	6,79	5,15	1166	12
	1400	11,47	7,51	1967	32	10,36	7,01	1778	26	9,16	6,49	1572	21	7,83	5,94	1345	16

Note

For the precise calculation of the performances, with air flow rate and available static pressure out of the nominal conditions, please refer to the Galletti selection software.

7 PERFORMANCES

7.1 COOLING CAPACITY

T_{bs1} Inlet air temperature D.B.
T_{bu1} Inlet air temperature W.B.
T_{w1} Inlet water temperature
T_{w2} Outlet water temperature
Q_a Air flow

PFT Total cooling capacity
PFS Sensible cooling capacity
Q_w Water flow rate
ΔP_w Pressure drop on water side

T_{bs1} / T_{bu1} (UR₁)	°C	27 / 19 (47%)															
T_{w1} / T_{w2}	°C	6/11				7/12				8/13				9/14			
	Q_a	PFT	PFS	Q_w	Δp_w	PFT	PFS	Q_w	Δp_w	PFT	PFS	Q_w	Δp_w	PFT	PFS	Q_w	Δp_w
	m ³ /h	kW	kW	l/h	kPa	kW	kW	l/h	kPa	kW	kW	l/h	kPa	kW	kW	l/h	kPa
PWN 13	300	2,26	1,56	388	6	2,01	1,46	345	5	1,71	1,34	293	4	1,44	1,23	247	3
	400	2,92	2,01	501	9	2,61	1,88	448	8	2,25	1,74	386	6	1,84	1,58	315	4
	500	3,53	2,43	605	13	3,16	2,27	542	11	2,74	2,11	470	8	2,27	1,93	390	6
PWN 14	300	2,66	1,76	456	10	2,42	1,66	415	9	2,15	1,54	369	7	1,84	1,42	317	5
	400	3,45	2,29	591	16	3,14	2,16	539	14	2,79	2,01	479	11	2,42	1,86	416	8
	500	4,19	2,79	719	23	3,82	2,63	655	19	3,40	2,45	583	15	2,95	2,27	507	12
PWN 16	300	2,88	1,88	494	8	2,64	1,77	453	7	2,37	1,65	407	6	2,05	1,52	353	4
	400	3,79	2,49	651	13	3,49	2,34	598	11	3,13	2,19	538	9	2,75	2,03	472	7
	500	4,68	3,07	802	18	4,29	2,89	737	16	3,86	2,70	663	13	3,40	2,51	584	10
PWN 23	600	4,46	3,03	765	12	3,99	2,84	685	10	3,48	2,63	597	8	2,89	2,41	497	6
	800	5,67	3,84	972	18	5,08	3,60	873	15	4,46	3,35	765	12	3,76	3,09	646	9
	1000	6,78	4,58	1162	25	6,08	4,30	1044	21	5,34	4,01	918	16	4,54	3,70	779	12
PWN 24	600	4,68	3,20	804	6	4,12	2,96	706	5	3,42	2,68	587	3	2,97	2,51	510	3
	800	6,13	4,15	1053	9	5,45	3,87	936	8	4,69	3,56	805	6	3,75	3,20	644	4
	1000	7,47	5,02	1282	13	6,67	4,68	1144	11	5,78	4,33	993	8	4,77	3,94	820	6
PWN 26	600	5,45	3,59	935	11	4,96	3,37	852	9	4,43	3,14	760	7	3,83	2,89	657	6
	800	7,10	4,68	1218	17	6,47	4,40	1111	14	5,80	4,11	995	12	5,06	3,81	868	9
	1000	8,66	5,70	1486	24	7,90	5,37	1355	20	7,08	5,02	1215	17	6,19	4,66	1063	13
PWN 33	1000	7,26	4,84	1245	19	6,53	4,54	1120	16	5,74	4,23	985	13	4,87	3,89	836	9
	1200	8,41	5,58	1444	25	7,57	5,23	1299	21	6,67	4,88	1145	16	5,68	4,50	976	12
	1400	9,50	6,26	1630	31	8,55	5,88	1468	25	7,54	5,48	1295	20	6,44	5,07	1107	15
PWN 34	1000	8,19	5,44	1404	19	7,41	5,11	1272	16	6,58	4,76	1129	13	5,66	4,39	972	10
	1200	9,57	6,35	1642	25	8,67	5,96	1488	21	7,71	5,57	1323	17	6,65	5,15	1143	13
	1400	10,89	7,20	1868	31	9,86	6,77	1693	26	8,77	6,32	1507	21	7,59	5,86	1304	16
PWN 36	1000	9,51	6,19	1632	23	8,74	5,83	1500	20	7,90	5,46	1358	16	7,00	5,08	1202	13
	1200	11,26	7,32	1931	31	10,34	6,90	1774	26	9,35	6,47	1606	22	8,29	6,02	1423	18
	1400	12,95	8,41	2221	39	11,89	7,93	2039	34	10,75	7,43	1846	28	9,53	6,92	1636	23

Note

For the precise calculation of the performances, with air flow rate and available static pressure out of the nominal conditions, please refer to the Galletti selection software.

7 PERFORMANCES

7.2 RESA IN RISCALDAMENTO

Tbs₁ Temperatura ingresso aria bulbo secco
Tw₁ Temperatura ingresso acqua
Tw₂ Temperatura uscita acqua
Qa Portata aria

PT Potenzialità termica resa
Qw Portata acqua
ΔPw Perdita di carico lato acqua

Tbs₁ / Tbu₁ (UR₁)	°C	19											
Tw₁ / Tw₂	°C	50/45			60/50			70/60			90/70		
	Qa	PT	Qw	Δpw	PT	Qw	Δpw	PT	Qw	Δpw	PT	Qw	Δpw
	m ³ /h	kW	l/h	kPa	kW	l/h	kPa	kW	l/h	kPa	kW	l/h	kPa
PWN 13	300	2,23	388	5	3,45	301	3	4,42	388	5	5,95	263	2
	400	2,83	493	8	4,37	382	5	5,60	491	7	7,52	332	3
	500	3,38	588	10	5,22	456	6	6,69	587	9	8,95	395	5
PWN 14	300	2,42	421	7	3,77	329	5	4,77	419	7	6,50	287	3
	400	3,12	543	11	4,85	424	7	6,15	540	10	8,34	368	5
	500	3,78	657	16	5,86	512	10	7,45	654	14	10,07	444	7
PWN 16	300	2,56	445	5	4,01	350	3	5,04	442	5	6,93	306	2
	400	3,36	585	9	5,26	460	5	6,62	581	8	9,08	401	4
	500	4,14	720	12	6,46	565	8	8,15	715	11	11,14	492	6
PWN 23	600	4,25	739	9	6,58	574	6	8,40	737	9	11,29	498	4
	800	5,34	928	14	8,23	719	8	10,55	926	13	14,11	623	6
	1000	6,33	1100	19	9,74	851	11	12,52	1098	17	16,68	737	8
PWN 24	600	4,61	802	5	7,15	624	3	9,14	802	4	12,34	545	2
	800	5,90	1026	7	9,13	798	5	11,66	1023	7	15,69	692	3
	1000	7,08	1231	10	10,94	955	6	14,00	1229	9	18,77	829	4
PWN 26	600	4,93	856	8	7,68	671	5	9,71	852	7	13,26	585	3
	800	6,38	1110	12	9,93	868	7	12,57	1103	11	17,09	755	5
	1000	7,75	1348	17	12,04	1053	10	15,28	1341	15	20,71	914	7
PWN 33	1000	6,77	1177	14	10,45	913	9	13,38	1174	13	17,92	791	6
	1200	7,79	1355	18	12,01	1049	11	15,40	1351	17	20,57	908	8
	1400	8,75	1522	22	13,47	1177	14	17,31	1518	20	23,07	1018	10
PWN 34	1000	7,52	1307	14	11,66	1018	8	14,82	1301	12	20,02	884	6
	1200	8,74	1520	18	13,54	1183	11	17,25	1514	16	23,24	1026	8
	1400	9,91	1723	22	15,32	1339	13	19,57	1717	20	26,29	1160	10
PWN 36	1000	8,27	1439	15	12,92	1129	9	16,28	1429	14	22,27	983	7
	1200	9,77	1698	20	15,23	1330	13	19,22	1687	18	26,23	1157	9
	1400	11,21	1948	26	17,45	1525	16	22,07	1936	23	30,03	1326	11

Note

For the precise calculation of the performances, with air flow rate and available static pressure out of the nominal conditions, please refer to the Galletti selection software.

7 PERFORMANCES

7.2 HEATING CAPACITY

Tbs₁ Inlet air temperature D.B.
Tw₁ Inlet water temperature
Tw₂ Outlet water temperature
Qa Air flow

PT Heating capacity
Qw Water flow rate
ΔPw Pressure drop on water side

Tbs₁ / Tbu₁ (UR₁)	°C	20											
Tw₁ / Tw₂	°C	50/45			60/50			70/60			90/70		
	Qa	PT	Qw	Δpw	PT	Qw	Δpw	PT	Qw	Δpw	PT	Qw	Δpw
	m ³ /h	kW	l/h	kPa	kW	l/h	kPa	kW	l/h	kPa	kW	l/h	kPa
PWN 13	300	2,13	370	5	3,35	292	3	4,32	379	4	5,84	258	2
	400	2,70	470	7	4,24	371	4	5,47	480	7	7,38	326	3
	500	3,23	562	10	5,06	442	6	6,53	573	9	8,78	388	4
PWN 14	300	2,31	402	7	3,66	320	4	4,66	409	6	6,38	282	3
	400	2,98	519	11	4,71	412	7	6,01	527	10	8,19	362	5
	500	3,61	628	15	5,69	497	9	7,28	638	14	9,89	436	7
PWN 16	300	2,45	426	5	3,89	340	3	4,93	432	5	6,81	301	2
	400	3,22	560	8	5,11	446	5	6,47	567	8	8,92	394	4
	500	3,96	689	12	6,28	549	7	7,96	698	11	10,94	483	5
PWN 23	600	4,06	707	9	5,82	508	8	8,20	720	8	11,08	489	4
	800	5,10	886	13	7,99	698	8	10,31	904	12	13,86	612	6
	1000	6,04	1051	17	9,45	826	11	12,22	1072	16	16,38	723	8
PWN 24	600	4,41	766	4	6,61	578	12	8,92	783	4	12,11	535	2
	800	5,64	980	7	8,85	774	4	11,39	999	7	15,40	680	3
	1000	6,76	1176	9	10,61	927	6	13,68	1199	9	18,43	814	4
PWN 26	600	4,71	819	7	7,40	646	10	9,48	832	7	13,02	575	3
	800	6,11	1062	11	9,65	843	7	12,28	1077	10	16,79	741	5
	1000	7,41	1290	15	11,70	1022	10	14,92	1309	15	20,34	898	7
PWN 33	1000	6,47	1125	13	10,14	886	8	13,06	1146	13	17,59	776	6
	1200	7,44	1294	17	11,65	1018	11	15,05	1319	16	20,20	892	8
	1400	8,36	1453	21	13,07	1142	13	16,90	1483	20	22,65	1000	9
PWN 34	1000	7,19	1249	13	11,32	988	8	14,48	1271	12	19,66	868	6
	1200	8,36	1453	16	13,14	1148	10	16,85	1479	15	22,81	1007	8
	1400	9,47	1646	20	14,87	1300	13	19,11	1676	19	25,81	1140	9
PWN 36	1000	7,92	1377	14	12,55	1097	9	15,90	1395	13	21,88	965	7
	1200	9,34	1625	19	14,79	1292	12	18,78	1647	18	25,76	1137	9
	1400	10,72	1864	24	16,95	1481	15	21,55	1891	22	29,49	1302	11

Note

For the precise calculation of the performances, with air flow rate and available static pressure out of the nominal conditions, please refer to the Galletti selection software.

7 PERFORMANCES

7.3 MDF COIL HEATING CAPACITY (4 PIPE SYSTEM)

Tbs₁ Inlet air temperature D.B.
Tw₁ Inlet water temperature
Tw₂ Outlet water temperature

Qa Air flow
PT Heating capacity
Qw Water flow rate
ΔPw Pressure drop on water side

Tbs₁ / Tbu₁ (UR₁)		19												
°C		50/45				60/50			70/60			90/70		
Tw₁ / Tw₂		Qa	PT	Qw	Δpw	PT	Qw	Δpw	PT	Qw	Δpw	PT	Qw	Δpw
		m ³ /h	kW	l/h	kPa	kW	l/h	kPa	kW	l/h	kPa	kW	l/h	kPa
MDF 1V	300	1,35	236	3	2,05	179	2	2,75	241	3	3,55	157	1	
	400	1,59	277	4	2,41	211	2	3,22	282	4	4,16	184	2	
	500	1,79	312	5	2,71	237	3	3,61	317	4	4,67	206	2	
MDF 2V	600	2,63	457	4	3,99	348	3	5,27	462	4	6,87	303	2	
	800	3,07	533	6	4,66	408	3	6,14	538	5	7,98	352	2	
	1000	3,43	596	7	5,21	455	4	6,87	602	7	8,90	393	3	
MDF 3V	1000	5,80	1009	7	8,90	778	4	11,52	1011	6	15,25	673	3	
	1200	6,61	1149	9	10,12	885	5	13,12	1150	8	17,33	765	4	
	1400	7,35	1278	11	11,26	984	6	14,60	1281	10	19,26	850	5	
Tbs₁ / Tbu₁ (UR₁)		20												
°C		50/45				60/50			70/60			90/70		
Tw₁ / Tw₂		Qa	PT	Qw	Δpw	PT	Qw	Δpw	PT	Qw	Δpw	PT	Qw	Δpw
		m ³ /h	kW	l/h	kPa	kW	l/h	kPa	kW	l/h	kPa	kW	l/h	kPa
MDF 1V	300	1,29	224	3	1,98	173	2	2,68	235	3	3,48	153	1	
	400	1,51	263	3	2,33	203	2	3,14	275	3	4,08	180	2	
	500	1,70	296	4	2,62	229	3	3,52	309	4	4,58	202	2	
MDF 2V	600	2,50	434	4	3,86	337	2	5,14	451	4	6,74	298	2	
	800	2,92	508	5	4,51	394	3	5,99	526	5	7,83	346	2	
	1000	3,27	568	7	5,04	441	4	6,70	588	6	8,74	386	3	
MDF 3V	1000	5,54	963	6	8,62	753	4	11,25	986	6	11,25	986	6	
	1200	6,31	1096	8	9,82	858	5	12,80	1123	8	12,80	1123	8	
	1400	7,02	1220	10	10,91	954	6	14,26	1250	9	14,26	1250	9	

Note

For the precise calculation of the performances, with air flow rate and available static pressure out of the nominal conditions, please refer to the Galletti selection software.

8 INSTALLATION SUGGESTIONS

PWN units are suitable for concealed installation, for horizontal operation. Choose the unit position to have the best ductwork path.

We suggest to connect the different optional of the unit before its final installation and following the instruction reported in the user manual.

The suction and delivery side are rectangular provided with holes for the connection with other options

- To connect the unit to rectangular ductsw we suggest the use of the RD or RDC options, to be mounted respectively on the suction/delivery side.
- To connect the unit to flexible dicts, we suggest the use of the PMA or PMAC options, to be mounted respectively on the suction/delivery side.

Ductworks, in particular the air outlet one, must be insulated to avoid moisture formation.

Keep free space around the fan coil to allow proper operation of the unit and ordinary and extraordinary maintenance.

Install the remote control panel, if any, in a position that can easily be reached by the user to set the functions and that is suitable for the proper detection of the temperature, if provided.

Therefore avoid:

- positions directly exposed to sunlight;
- positions exposed to hot or cold draughts;
- obstacles preventing the proper temperature detection.

If the system is shut down during the winter months, drain off the water from

the system to prevent damage due to freezing; if antifreeze solutions are used, check the freezing point using the table shown at the foot of the page.

Glycol percentage in weight	0	10	20	30	40
Freezing temperature (°C)	0	-4	-10	-16	-24
Capacity correction factor	1,00	0,97	0,92	0,87	0,82
Pressure drop correction factor	1,00	1,05	1,10	1,15	1,20

Coefficients should be used only for a quick calcolation; to obtain precise data please refer to the Galletti calculation software.

9 DIMENSIONAL DATA

- 1 water outlet, 3/4" gas female
- 2 water inlet, 3/4" gas female
- 3 electrical connections box
- 4 cable-pressing for power supply
- 5 drain outlet, $\phi 17$ mm

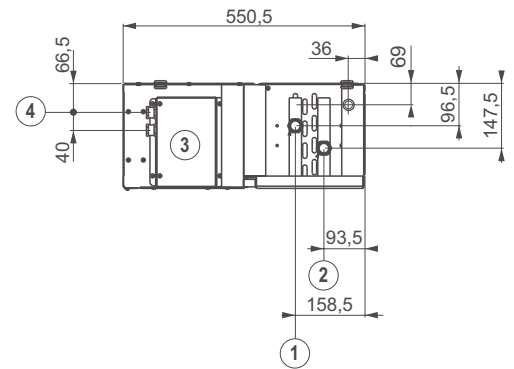
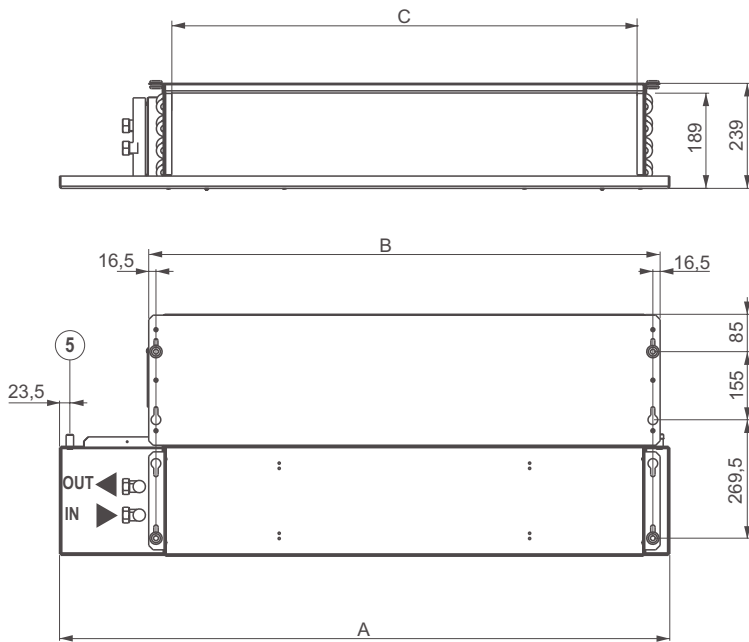

	PWN 1	PWN 2	PWN 3
A	1039	1389	1739
B	814	1164	1514
C	709	1059	1409

10 WIRING DIAGRAMS

WARNING! Turn off the power supply before beginning any wiring connections.

The dashed lines connections must be carried out by the installer.

Each fan-coil thermal-ventilating unit requires a switch (IL) on the feeder line with a distance of at least 3 mm between the opening contacts, and a suitable safety fuse (F).

The fan's motor is provided with 7 speed.

ATTENTION:

The **COMMON** wire of the motor is the **WHITE** one: if connected incorrectly the motor would be damaged irreparably.

On the wiring diagram the following abbreviations are used:

- IL** mains switch (not supplied)
- F** protection fuse (not supplied)
- 3/7** 3 of the 7 available
- M** Motor
- WH** White= commun
- BK** black= velocità massima
- BU** blue
- BN** brown
- GY** grey
- GN** green
- YE** yellow
- RD** Red = minimum speed
- GNYE** yellow/green = ground (PE)
- SF** Centralized mode selection switch (not supplied)
- VK** water valve (230V ON-OFF)
- VKC** Child water valve (230V ON-OFF)
- VKH** Hot water valve (230V ON-OFF)
- KP** power interface for the connecting up to 4 units to one control panel
- IPM** power interface
- EXT** external auxiliary contact
- RHC** Centralized mode selection switch (not supplied)
- TC** Fan-off thermostat

MOTORS ELECTRICAL DATA

The following table describes the characteristics of the motors at available working conditions.

- Vr** Operation speed
- P_{ASS}** Power input
- I_{ASS}** Operation current

Model	Vr	I _{ass} (A)	P _{ass} (W)	Model	Vr	I _{ass} (A)	P _{ass} (W)	Model	Vr	I _{ass} (A)	P _{ass} (W)
PWN 1	1	0,18	34	PWN 2	1	0,41	76	PWN 3	1	0,73	155
	2	0,21	40		2	0,49	92		2	0,76	164
	3	0,24	47		3	0,59	115		3	0,82	177
	4	0,29	56		4	0,74	143		4	0,88	193
	5	0,34	69		5	0,79	155		5	1,00	224
	6	0,41	85		6	0,84	167		6	1,10	252
	7	0,51	106		7	0,94	192		7	1,28	294

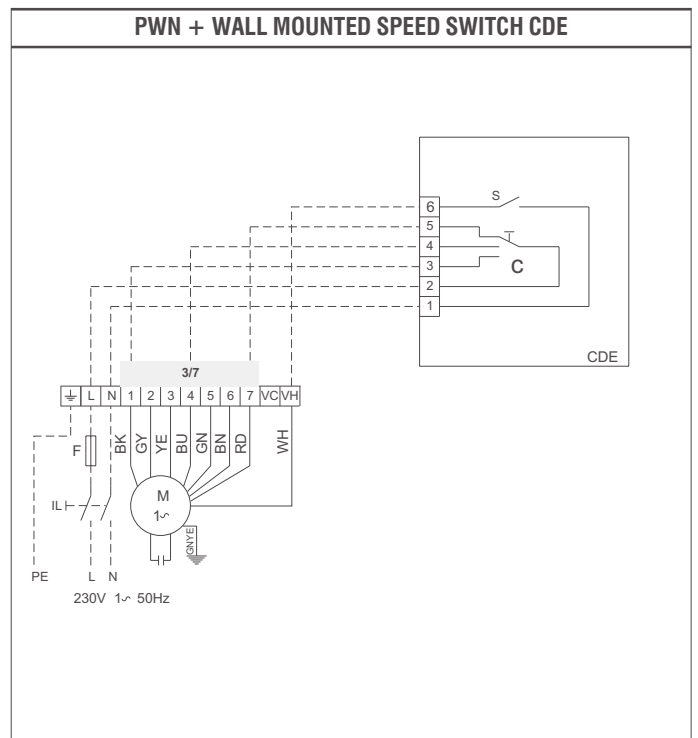
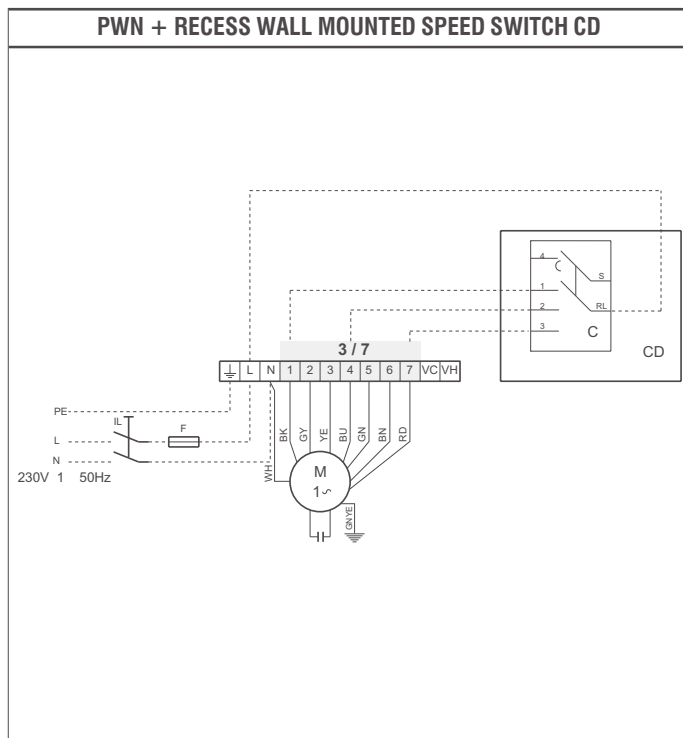

10 WIRING DIAGRAMS

PWN + TD CONTROL PANEL

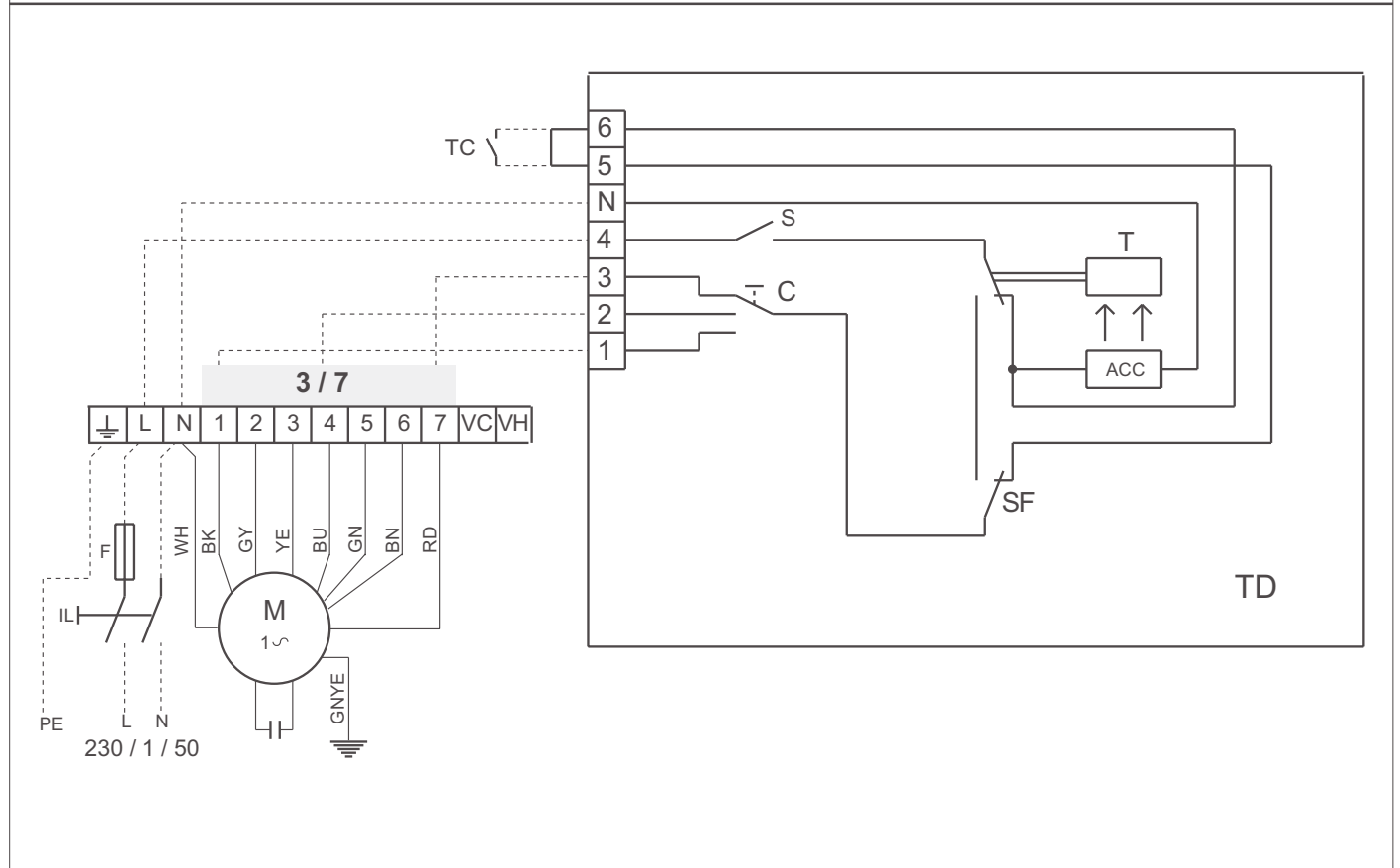

PWN + TDC CONTROL PANEL, CENTRALIZED SUMMER/WINTER SELECTION.

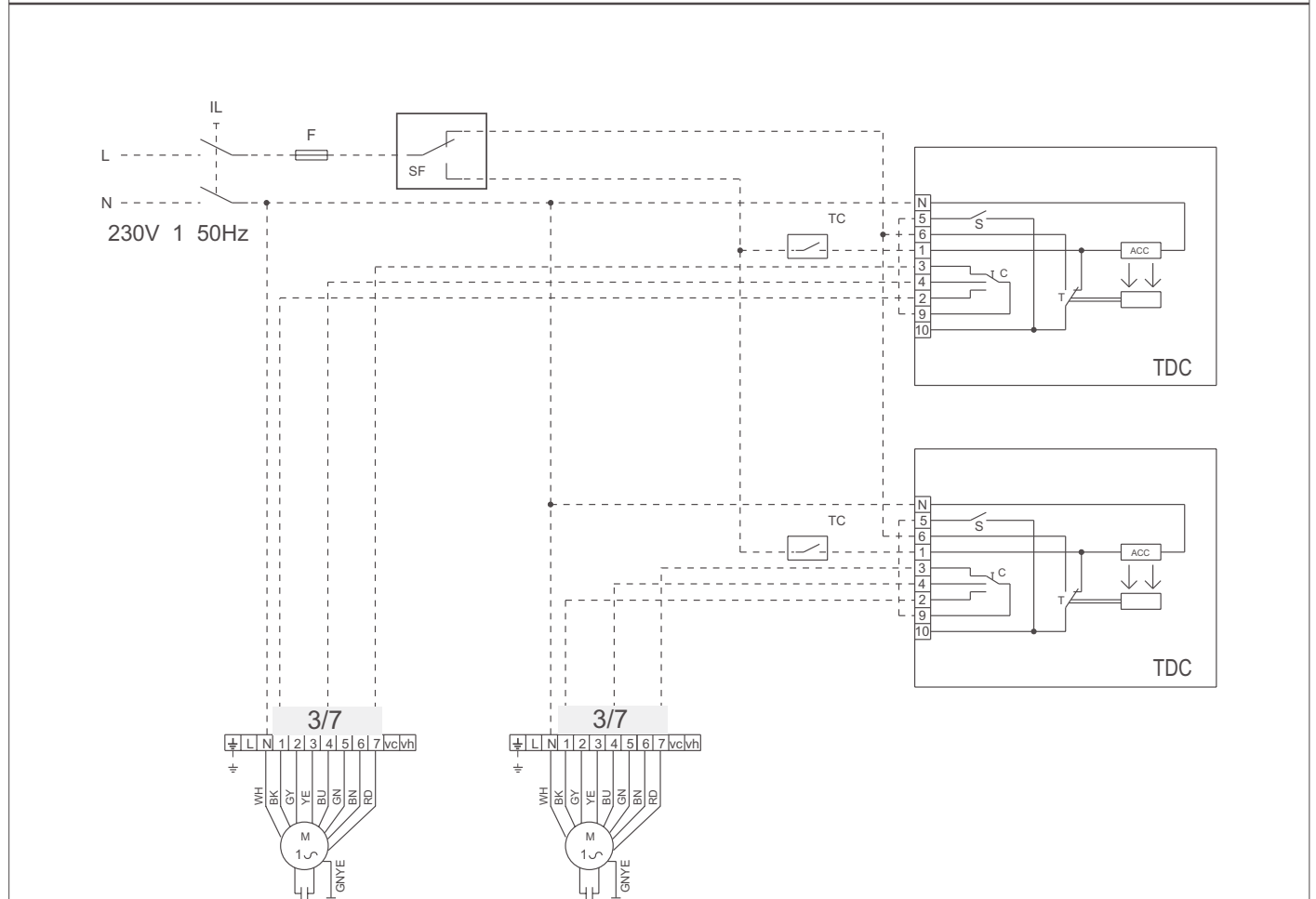

10 WIRING DIAGRAMS

PWN + TD4T CONTROL PANEL, WITH 1 VALVE

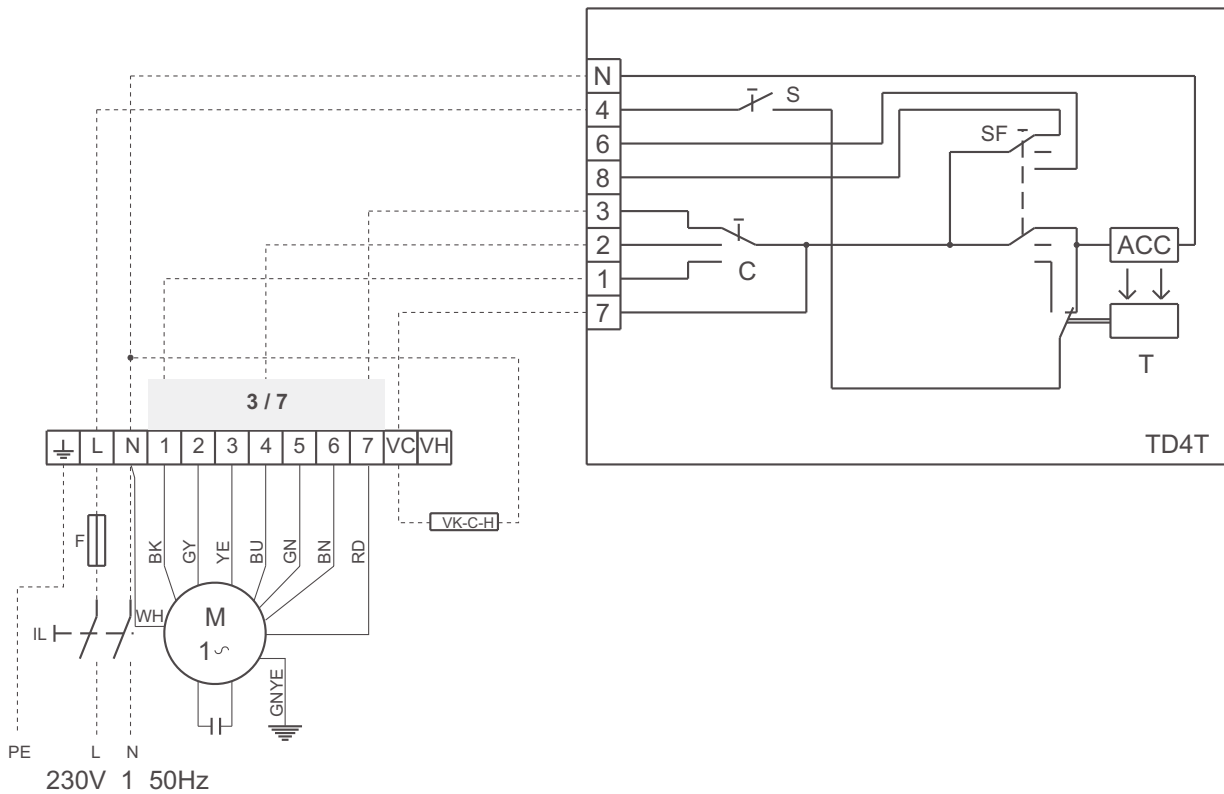

PWN + TD4T CONTROL PANEL, WITH 2 VALVES

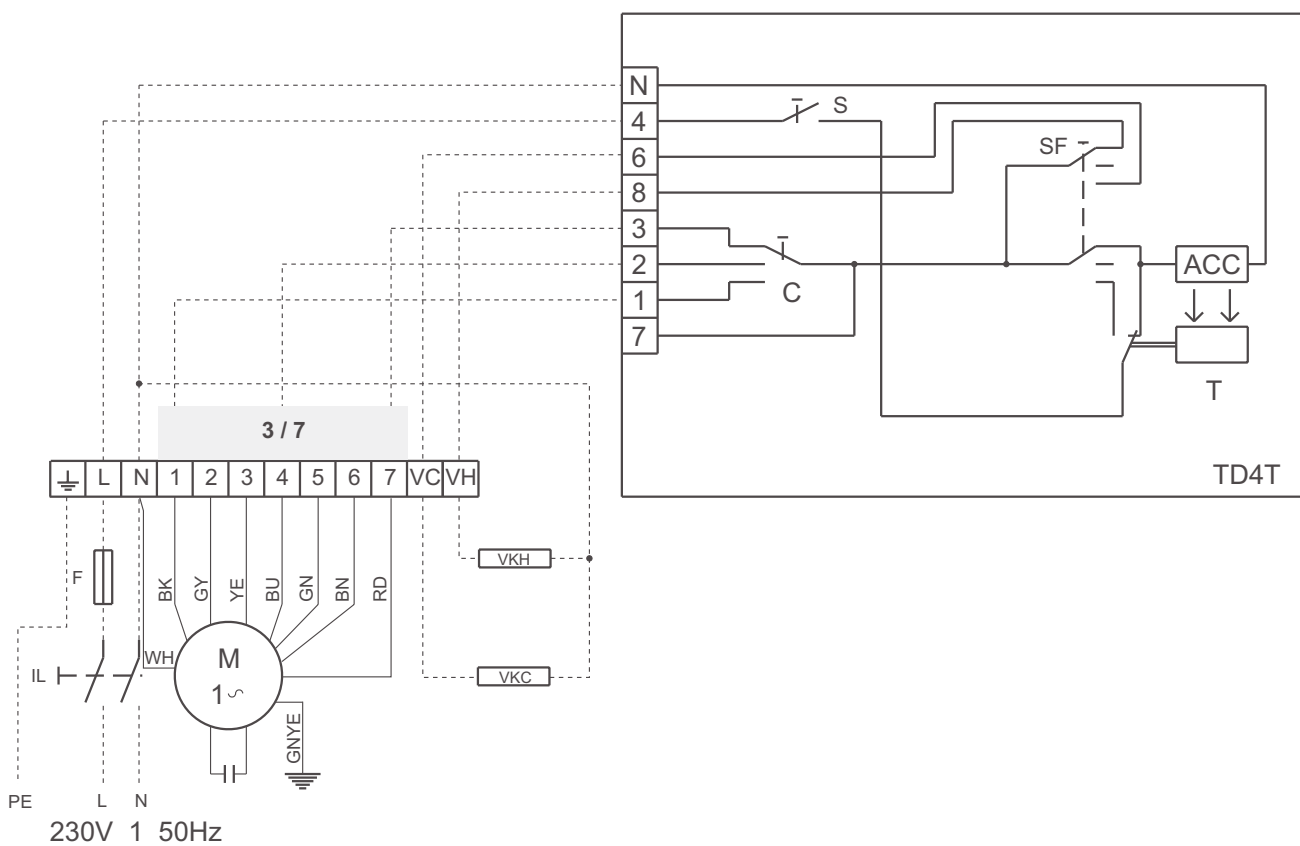

10 WIRING DIAGRAMS

PWN+MICROPROD (PWN 1 AND PWN 2)

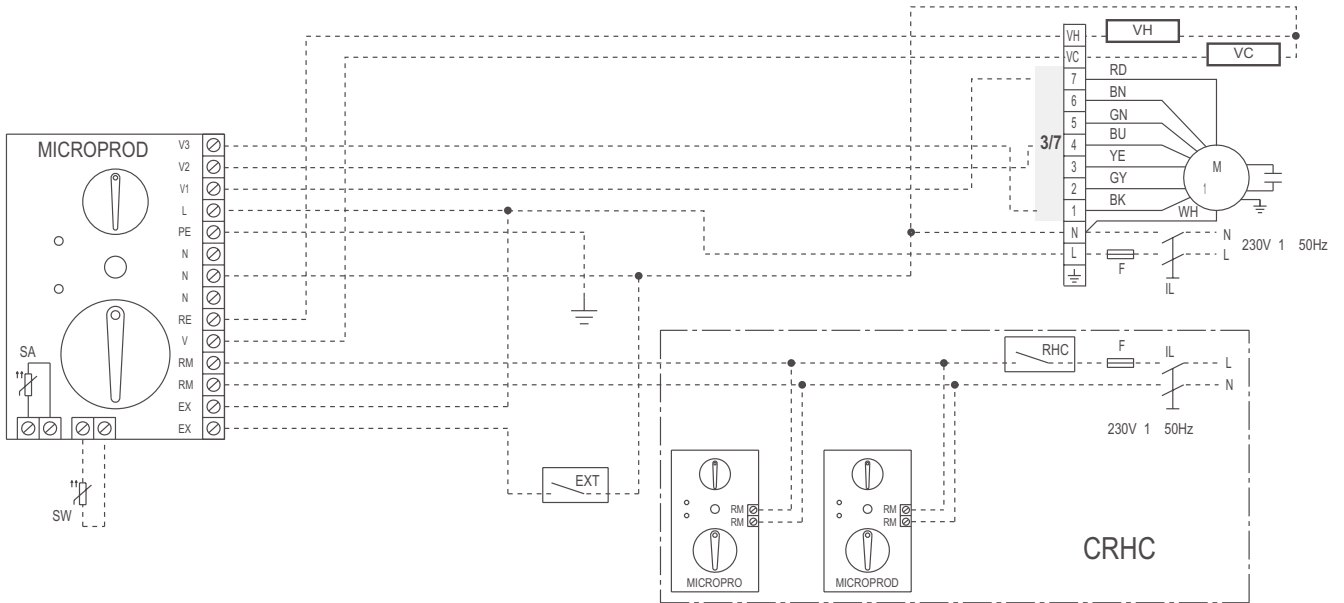

PWN+MICROPROD + IPM (PWN 3)

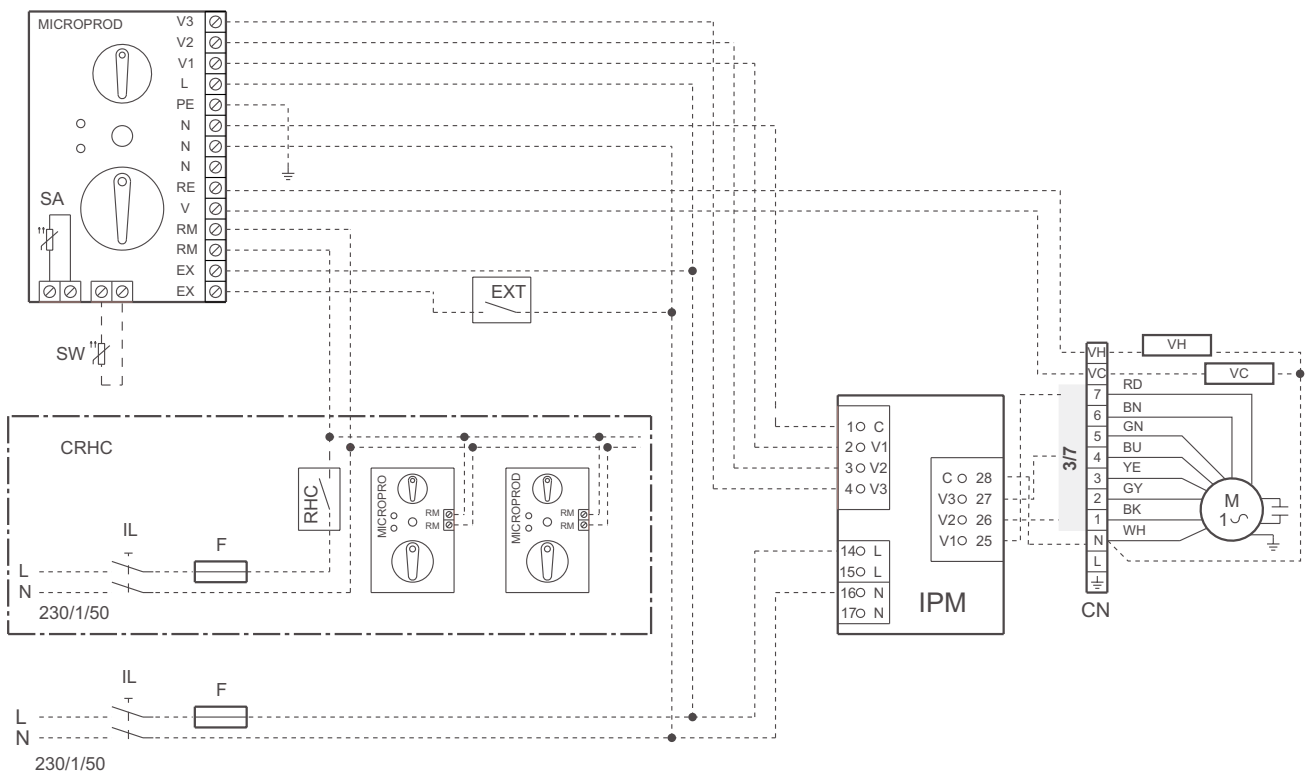

10 WIRING DIAGRAMS

PWN+MICROPROD + KP

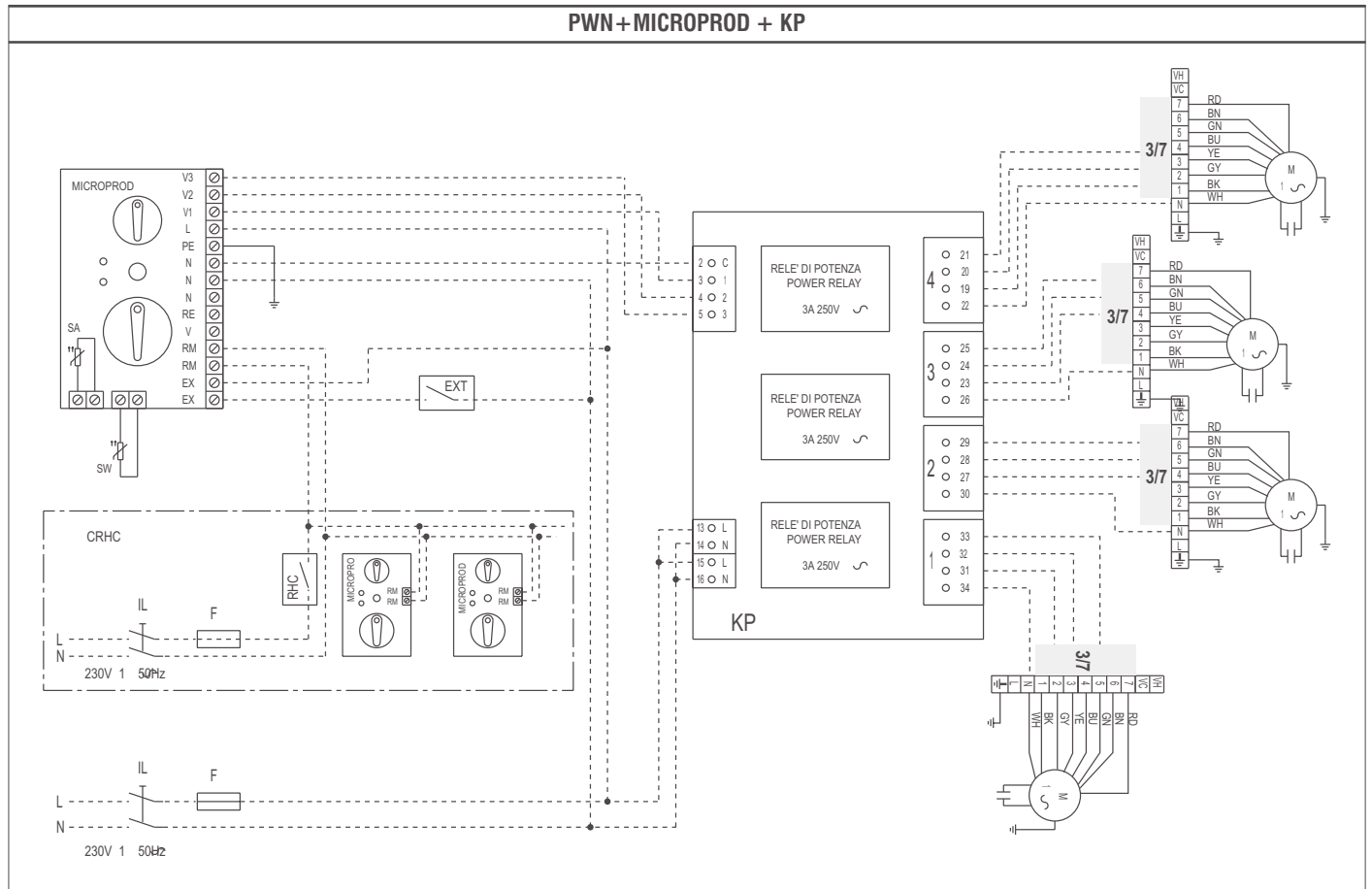

PWN+MICRO D+KP

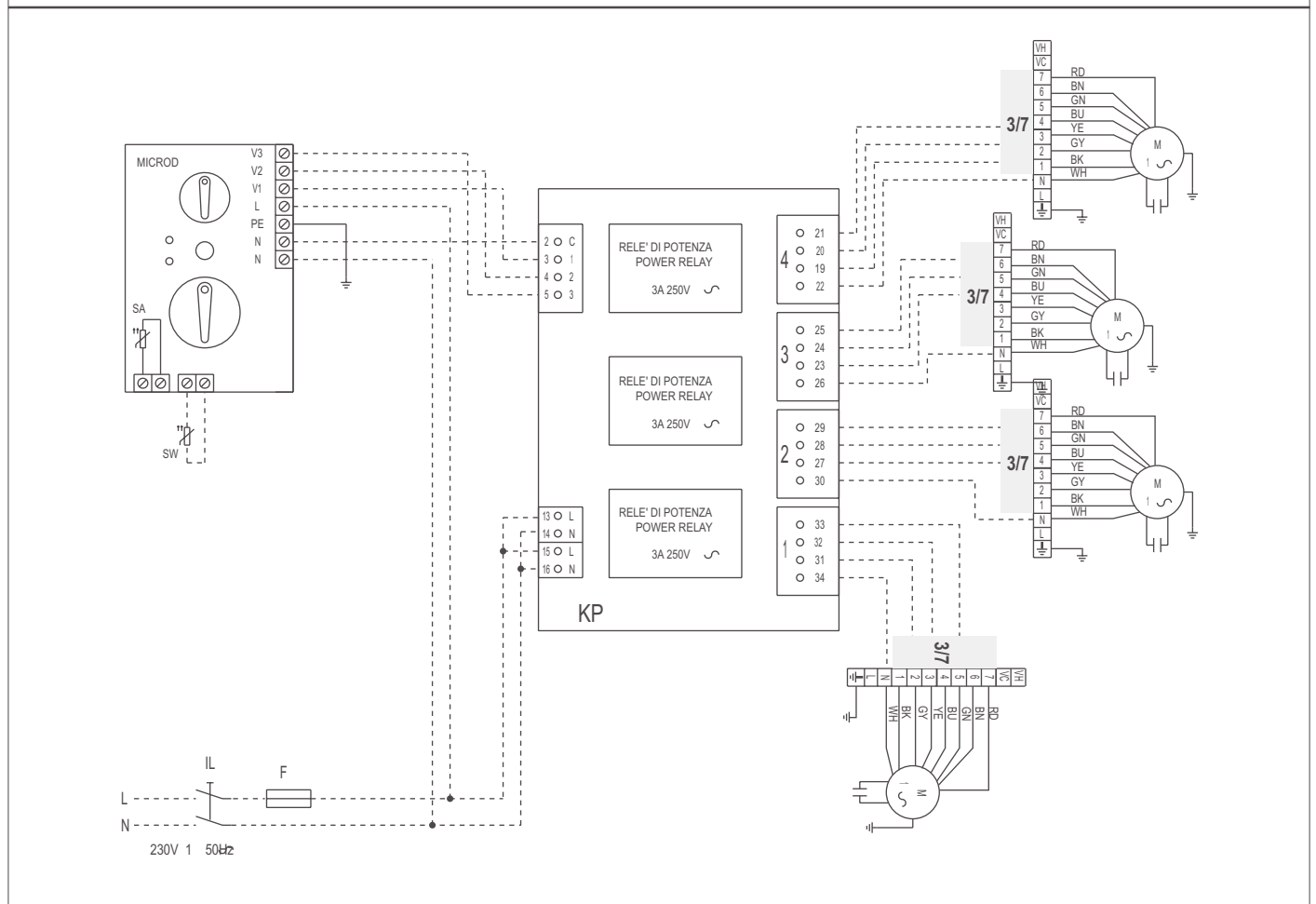

10 WIRING DIAGRAMS

PWN+MICRO D (PWN 1 AND PWN 2)

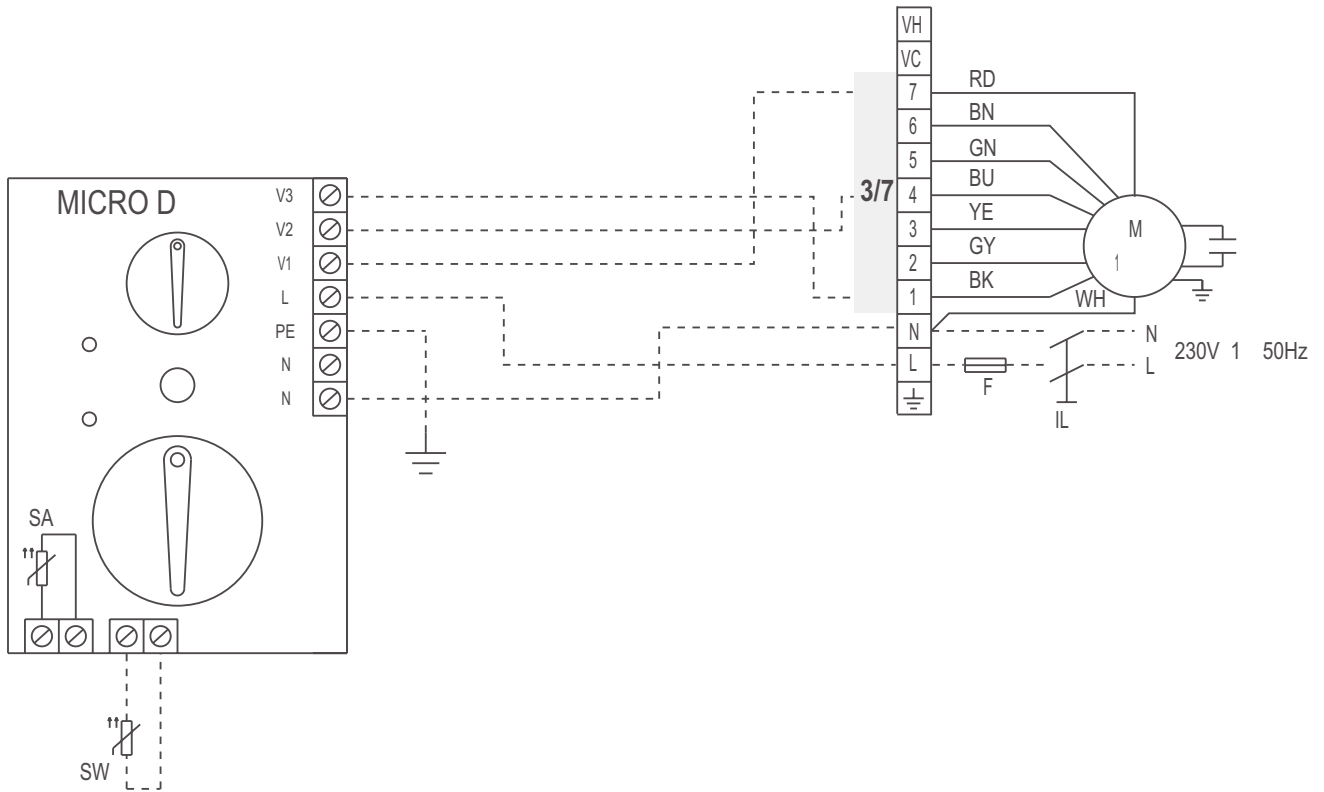

PWN+MICRO D+IPM (PWN 3)

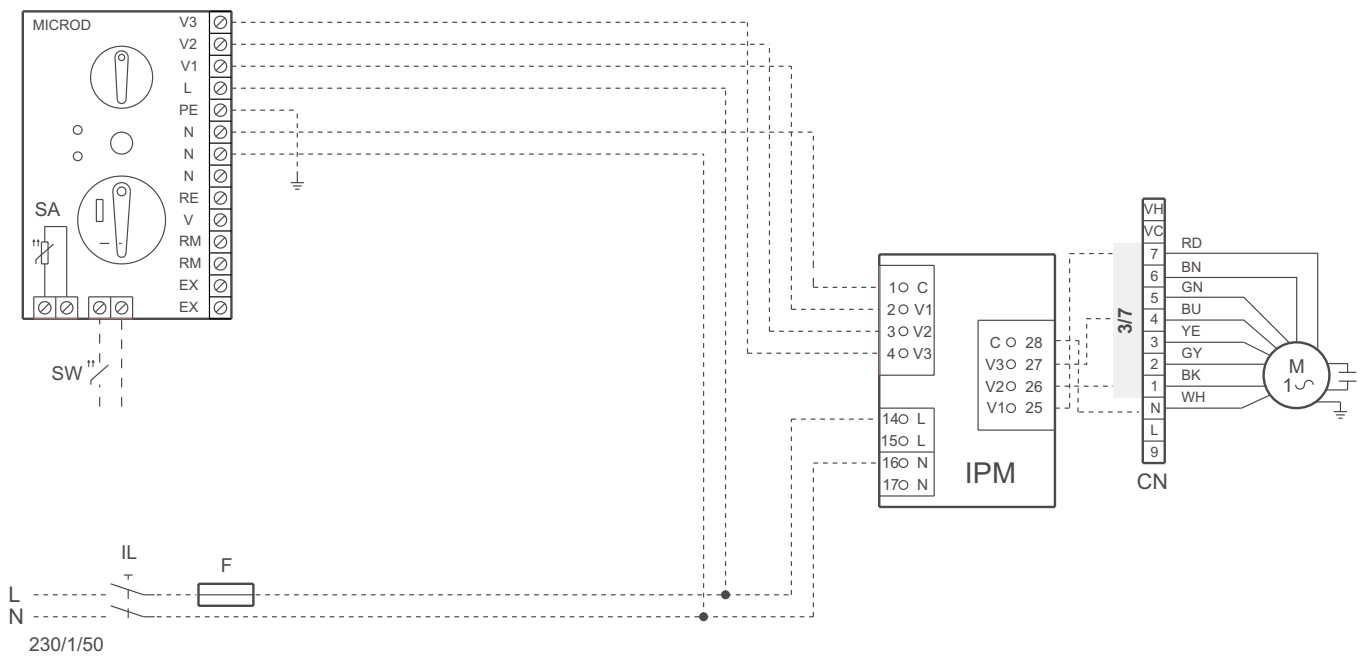

11 ACCESSORIES

CD - flush wall-mounted speed selector

Flush wall-mounted control panel is provided with a 4 positions (3speed + stop) rotation selector. The CD control panel allows the ON/OFF and fan speed selection of the high pressure fan coil unit.



CDE - wall mounted speed selector

Wall mounted control panel is provided with a 3 positions (3 speed) and switch ON/OFF .

The CDE control panel allows the ON/OFF and fan speed selection of the high pressure fan coil unit.



TD - wall mounted control with speed selector, thermostat and summer-winter selector

Wall mounted control panel complete with fan speed selector, electromechanical thermostat and cooling / heating mode selector.

Fan speed control, regulation of the room temperature and cooling heating mode selection:

- manual setting of the fan speed;
- room temperature regulation both in cooling / heating mode, by means of fan start / stop, at a manually set temperature.



TDC - wall mounted control with speed selector and thermostat

Wall mounted control panel complete with fan speed selector, electromechanical thermostat and cooling / heating mode selector.

Fan speed control, regulation of the room temperature and cooling / heating mode selection:

- manual setting of the fan speed;
- room temperature regulation both in cooling / heating mode, by means of fan start/stop, at a manually set temperature.



TD4T - wall mounted control with speed selector, thermostat and summer-winter selector, for 2/4 pipe system with valves

Wall mounted control panel provided with fan speed selector, electromechanical thermostat,

and cooling / heating mode selector; if installed it controls regulating valves.

Fan speed control and regulation of the room temperature:

- manual setting of the operation fan speed;
- regulation of the room temperature for 2 and 4 pipe systems, both in heating and cooling mode, by means of fan start/stop at a manually set temperature and by means of opening and closing of the regulating valve.



TA- wall mounted room thermostat

Automatic regulation of the room temperature:

- only in the heating mode working on the fan motor assembly and on the regulating valve, if installed (ON/OFF operation);
- only in the cooling mode working on the fan motor assembly and on the regulating valve, if installed (ON/OFF operation);
- both in cooling and heating mode, with remote mode selection working on the fan motor assembly and on the regulating valve, if installed (ON/OFF operation).



TA2 - wall mounted room thermostat with summer/winter selector

Wall mounted room thermostat with cooling / heating mode selector.

Automatic regulation of the room temperature both in heating and cooling mode, working on the fan motor assembly and on the regulating valve if installed (ON/OFF operating).



TC - fan stop thermostat: electromechanical thermostat for minimum water temperature during heating

Fan stop thermostat with automatic resetting, it stops the fan motor assembly when the water temperature in the heat exchanger decreases under the set value (42°C).

Usefull only in the heating mode for installation on the finned pack of the heat exchanger.

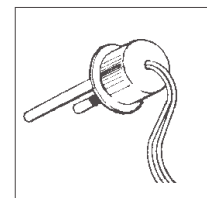

MICROD- microprocessor control panels

Microprocessor control panels for in built (MICRO) or wall (MICRO-D) installation, complete with fan speed selector, electronic thermostat and cooling / heating mode selector; for the automatic control of the fan coil unit.

Fan speed control, room temperature regulation and cooling / heating mode selection:

- regulation of the room temperature both in the cooling and heating mode, by means of fan start/stop, at a manually set temperature;
- regulation of the room temperature, both in the cooling and heating mode, by means of the automatic regulation of the fan speed;
- timer function (not available for MICRO-D);
- cooling / heating mode selection in the following ways:
 - manual in built;
 - automatic according to the water temperature (with the SW water probe; option).



MICROPROD- advanced microprocessor control panels

Microprocessor control panels for in built (MICROPRO) and wall (MICROPRO-D) installation complete with fan speed selector, electronic thermostat and cooling / heating mode selector; for the automatic control of the fan working on the valves and electric heater, if installed.

Fan speed control, room temperature regulation and cooling / heating mode selection:

- room temperature regulation both in the cooling and heating mode, by means of fan start/stop, at a manually set speed;
 - room temperature regulation both in the cooling and heating mode, by means of the automatic regulation of the fan speed;
 - timer function (not available for MICROPRO-D);
 - cooling / heating mode selection in the following way:
 - manual in built;
 - manual remote (centralized);
 - automatic according to the water temperature (with the SW water probe, option for MICROPRO-D, included in MICROPRO kit);
 - automatic according to the room temperature (with air temperature probe, option);
 - control of the ON/OFF valves for 2 or 4 pipe system;
 - control of the electric heater as integration or replacement of the hot water heat exchanger with delayed stop of the fan (2 min.).
- The MICROPRO / MICROPRO-D control panels are provided also with contacts for external signals in order to enable or disable the unit operation.



11 ACCESSORIES

MICRONET- Advanced microprocessor control panels for ergo solution

MICRONET is the control panel suitable for the connection to the ERGO SOLUTION. Microprocessor control panels for wall installation complete with fan speed selector, electronic thermostat and cooling / heating mode selector; for the automatic control of the fan working on the valves and electric heater, if installed.



Fan speed control, room temperature regulation and cooling / heating mode selection:

- room temperature regulation both in the cooling and heating mode, by means of fan start/stop, at a manually set speed;
- room temperature regulation both in the cooling and heating mode, by means of the automatic regulation of the fan speed;
- timer function (not available for MICROPRO-D);
- cooling / heating mode selection in the following way:
 - manual in built;
 - automatic according to the water temperature;
 - automatic according to the room temperature;
 - control of the ON/OFF valves for 2 or 4 pipe system;
 - control of the electric heater as integration or replacement of the hot water heat exchanger with delayed stop of the fan (2 min.).

The MICRONET control panels are provided also with contacts for external signals in order to enable or disable the unit operation.

- terminals for the connections with external signals in order to enable or disable the unit operation;
- terminals for the connections with external signals in order to enable or disable the ECONOMY set point (only if combined with ERGO software)
- air temperature probe
- water temperature probe
- RS485
- built-in MODBUS communication protocol
- Built-in Polarity and termination resistance
- Protocollo di comunicazione MODBUS integrato
- Resistenze di polarizzazione e terminazione integrate attivabili tramite jumper

SW - Wall mounted room thermostat with summer/winter selector

Connected directly to the microprocessor control panel, this probe measures the water temperature inside the heat exchanger.

If the temperature is lower than 17°C the unit works in cooling mode and the temperature range of the control panel will be referred to the cooling mode (19/31°C); if the temperature registered is higher than 37°C the unit works in heating mode and the temperature range of the control panel will be referred to the heating mode (14/26°C).

If the temperature registered is between 17°C and 37°C the control panel will disable the unit operation.

The SW water probe is included in the MICROPRO and MICRONET.



IPM - Power interface for the connections to the control panels MICRO-D and MICROPRO-D

The IPM power board permits to use MICRO-D and MICROPRO-D microprocessor-based control panels on the whole range of PWN units, even for models with current consumption greayer than 1A.

The capacity of the IPM contacts is 16A, IP30 rating.

The use of the IPM power board matched with the microprocessor controls is compulsory for PWN 33, 34 and 36 models.

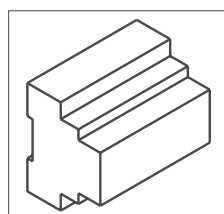

KP - power interface for connection of up to 4 units to a single control panel

The KP master sleeve can be installed to control with a single control panel up to 4 units (connected in parallel).

This accessory is designed for installation on a DIN drive, usually placed on electric board, can be matched with all PWN versions.

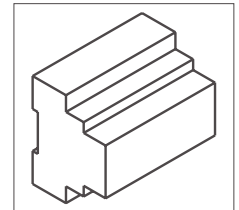

PMA / PMAC - plenum for the connection to flexible ducts

PMA e PMAC (insulated) plenums are used to connect to air distribution plants achieved by means of hoses or to other dedicated accessories.

They can be installed on both the intake and delivery line (in this case the hose should be insulated).

The spigot diameter is Φ 200 mm.

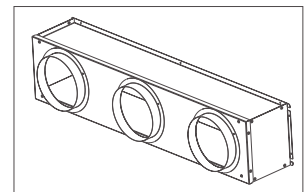

PWN	1	2	3
n° of outlet	2	3	5

RD / RDC - Suction/delivery straight connection

The allow the connetction of PWN units to rectangular ducts or directly to GM/GA grilles.

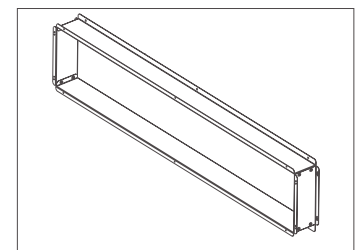

PAF - Front air intake plenum ϕ 200

Thanks to the PMA and PAF plenums it is possible to install the PWN units in installation where air suction and delivery must be carried out in a single side, reducing the space required for the installation.

Air suction is provided with ϕ 200 spigots.

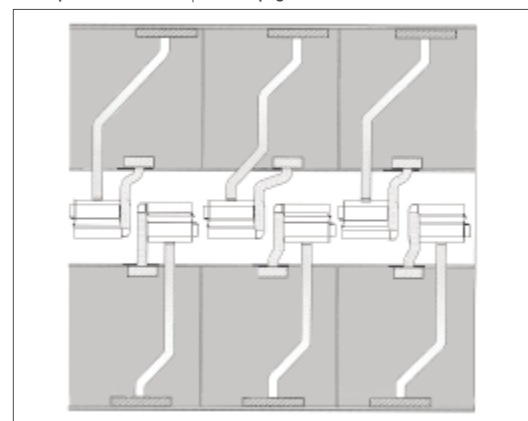
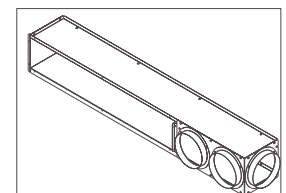

TFA - Not insulated flexible ducts

Uninsulated flexible duct for the connections to the air distribution with ϕ 200 mm diameter, supplied in 6 m lenght undivisible.

TFM - Insulated flexible ducts

Insulated flexible duct for the connections to the air distribution with ϕ 200 mm diameter, supplied in 6 m lenght undivisible. The insulation of the duct is obtained by means of fiberglass, thickness 25 mm with 16 Kg/m³ density.

TP- Plastic cap

Plastic cap ϕ 200 mm for the closing on the PCOF, of the air outlet not used.

11 ACCESSORIES

SM - Serranda motorizzata di presa aria esterna

Serranda motorizzata di presa aria esterna permette di effettuare rinnovi di aria dell'ambiente direttamente dall'unità termoventilante. La quantità di aria esterna da immettere in ambiente, una volta filtrata e trattata termicamente, è regolabile

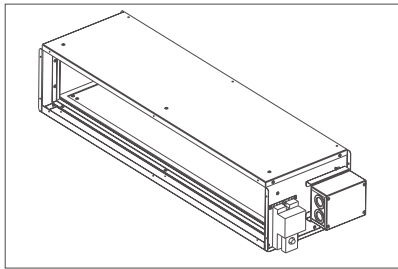

proporzionalmente da 0 a 100% mediante un servomotore comandato da un potenziometro rotativo, che si trova nell'apposito comando CSD, che è previsto per installazioni ad incasso a parete.

Il kit PA90 è composto principalmente da:

A) Serranda di presa aria esterna in lamiera di acciaio zincata e predisposta per il collegamento alla macchina, ad una estremità, ed agli altri accessori previsti.

B) Servomotore collegato direttamente al deflettore della serranda, con grado di protezione IP54, tensione di alimentazione 24V ~.

È possibile effettuare la chiusura o l'apertura automatica della serranda su segnale di contatti ausiliari esterni (non forniti) quali termostati antigelo, timer, ecc., con possibilità di collegamento in parallelo di più servomotori ad un unico comando di apertura-chiusura.

C) Trasformatore di tensione 230V - 24V, completo di morsetteria di appoggio, alloggiato all'interno dell'apposita scatola elettrica, che ha funzione di protezione meccanica, per impedire l'accesso alla morsetteria di collegamento ed al trasformatore.

D) Viti autofilettanti di fissaggio.

CSD - wall mounted control for proportional opening and closing of the PA90 motorized louvre

Designed for wall installation it allows the proportional opening and closing from 0 to 100% of the SM outdoor air intake motorized louvre

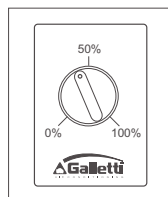

R90/R90C - 90° connection for intake/ delivery

To be connected on both suction and delivery (the R90C insulated version) side directly on the PWN unit

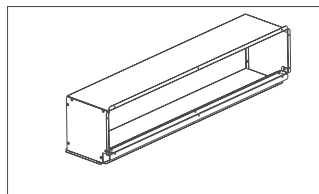

RE - additional electric heating element

Useful as heating integration to the hot water system, the RE kit is made of an electric heater with safety thermostat (automatic and manual resetting) and power relay.

The RE electric heater kit has to be matched with the MICROPRO-D control panel and with the IPM power board for the models PWN 3.

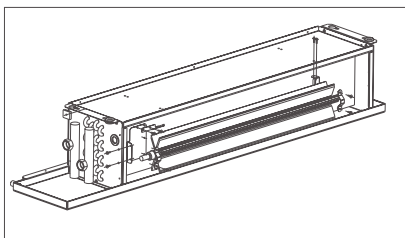

MDF - Additional heat exchanger module for hot water operation

For installation on air delivery, the MDF module is provided with one heat exchanger, for operation with hot water up to 95°C, to be used in 4 pipe system. It can be mounted with left or right water connection indifferently.

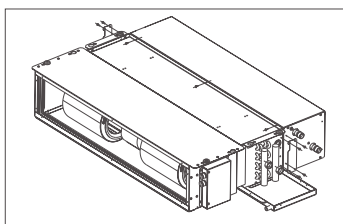

SIL - suction/delivery sound attenuator

Manufactured in galvanised steel, with sound proof baffles and internally insulated with high density absorbing (90 kg/cm³) and 10 mm thickness.

the sound absorbing material is protected by

a PCV film to avoid to release fibers or absorb dust.

The following table is reporting the sound attenuation of the sound power level in each frequency.



125 Hz	250 Hz	500 Hz	1 kHz	2 kHz	4 kHz	8 kHz
dB	dB	dB	dB	dB	dB	dB
1,5	2,0	2,3	2,9	4,1	5,3	3,8

VK - 3 way valve with ONOFF actuator and mounting kit

The system allows the regulation of the ambient temperature by stopping the water flow into the heat exchanger.

Available for 2 pipe and 4 pipe systems, the kit is made of the components below indicated:

Valve body: 3-way with in-built by-pass (4 connections):

Actuator: normally closed, electrothermal type, 230V single phase, with ONOFF operation, it works directly on the valve shutter.

Hydraulic connections kit: made of copper tubes and brass connections.

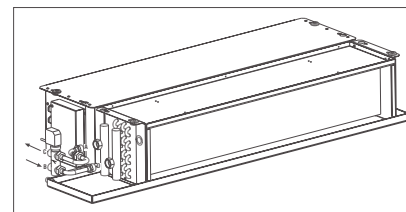

KSC - Condensate removal kit

This device allows to overcome displacements in the condensate drain.

The pump can drain water up to 8 l/h and it is completed by a non return valve on the discharge side.



CA/CAF - air inlet plenum box

Intake Plenum box in galvanised sheet metal complete with circular collars (Ø 200 mm) for the connection, by means of hoses and intake grids with fixed fins, to pocket type structures, to increase the free air flow cross section.

Sized to be adaptable to the modular structure of the ceiling panels, they are equipped with 2 or 3 circular collars so that they can be connected, following their suitable combination, to all the PWN units. The CA version is equipped with just the grid alone whereas the CAF version is also equipped with a flat filter in acrylic material, with filtering rating G2, housed in the standard frame.

The filter of this second type of intake box can be serviced (cleaned) on a periodic basis without having to access the unit fitted behind the ceiling panels or in a service room.

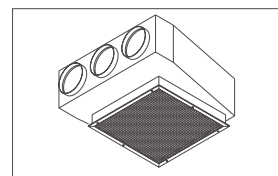

11 ACCESSORIES

CM - Delivery plenum boxes

Delivery Plenum boxes in galvanised sheet metal complete with circular collars (Ø 200 mm, for the connection by means of hoses) and adjustable delivery grids. The boxes are duly insulated externally with calorized foam polyethylene in order to prevent the formation of condensate during the cooling cycle. Sized to be adaptable to the modular structure of the ceiling panels, they are equipped with 1, 2 or 3 circular collars so that they can be connected, following their suitable combination, to all the heater fans of the PWN range. All versions are equipped with adjustable fins to optimise the distribution of the conditioned air.

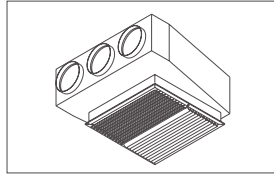

GM - Aluminium air outlet grille

Air delivery grids with double row of adjustable fins in anodised aluminium, equipped with galvanised sheet metal frame that is used to wall-mount the grids or to fit them directly on the delivery head of the machine.

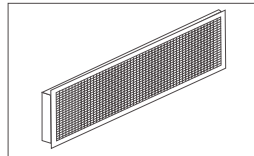

The galvanised sheet metal frame is drilled at one end so that it can be secured directly to the delivery head of the unit complete with RD connection.

GA - Aluminium air inlet grille

Air intake grids with single row of fins in anodised aluminium, equipped with galvanised sheet metal frame that is used to wall-mount the grids or to fit them directly on the intake head of the machine.

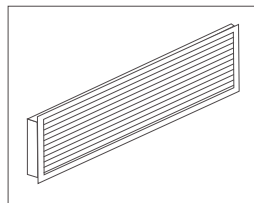

The galvanised sheet metal frame is drilled at one end so that it can be secured directly to the intake head of the unit complete with RD connection.



40010 Bentivoglio (BO)
Via Romagnoli, 12/a
Tel. 051/8908111
Fax 051/8908122
www.galletti.it